

APPENDIX D2

Brine Discharge Diffuser Analysis

This page intentionally left blank



DRAFT TECHNICAL MEMORANDUM

DATE: August 29, 2014

TO: Environmental Science Associates (ESA)

FROM: Gang Zhao, Ph.D., P.E., Aaron Mead, P.E., E. John List, Ph.D., P.E.

**SUBJECT: MRWPCA Brine Discharge Diffuser Analysis
FSI 134032**

1. INTRODUCTION

As part of the EIR preparation process for the Monterey Peninsula Water Supply Project, Flow Science Incorporated (Flow Science) was retained to analyze the effect that discharging desalination brine through the existing Monterey Regional Water Pollution Control Agency (MRWPCA) ocean outfall would have on ocean water quality adjacent to the outfall.

In August 2014, Flow Science performed a modeling analysis of four discharge scenarios for the Monterey Peninsula Water Supply Project, as summarized in **Table 1**. For each scenario, effluent dilution was analyzed for zero ocean current conditions.

Table 1 – Diffuser scenarios modeled

Scenario No.	Scenario Name	Discharge Rate (mgd*)
1	Upwelling (July), Brine Only	13.98
2	Davidson (Jan.), Brine Only	13.98
3	Davidson (Jan.), Brine and Wastewater	33.76 (= 13.98+ 19.78)
4	Oceanic (Sept.), Brine Only	13.98

*mgd = million gallons per day.

This Technical Memorandum (TM) summarizes the analyses Flow Science completed for



the four scenarios presented in **Table 1** and describes the input data, results, and methods Flow Science used to analyze the proposed discharges. Analyses for additional discharge scenarios were also completed by Flow Science, and the TM for these additional discharge scenarios is attached as **Appendix C**.

2. ANALYSIS INPUT DATA

Diffuser Configuration

The existing MRWPCA diffuser has 172 ports. Half of the ports discharge horizontally from one side of the diffuser and half discharge horizontally from the other side of the diffuser in an alternating pattern. Since Visual Plumes does not have the capability to model ports on alternating sides of a diffuser, all ports were modeled to be on one side of the diffuser. This simplification has no effect on the dilution of negatively buoyant plumes because all modeled negatively buoyant plumes (Scenarios 1, 2 and 4) did not overlap or interact before reaching the ocean floor—i.e., within the zone of initial dilution (ZID). For the positively buoyant cases (Scenario 3) the model results are conservative because the plumes from individual ports overlap more quickly under modeled conditions than in reality, and so modeled effluent dilutions for the positively buoyant scenarios are somewhat lower than would be reflected in reality.

According to MRWPCA, the fifty-two (52) ports nearest to the shore (i.e., the shallowest ports) are currently closed. In this analysis, Flow Science calculated plume concentrations for effluent discharged through the 120 open ports. A typical section of the current diffuser is shown in **Figure 1**, although the actual cross-sectional profile of the pipe ballast may have changed over time. The ports are approximately 6 inches above the rock bedding of the diffuser pipeline, and drawings¹ (see **Figure 1**) indicate that they are located a minimum of approximately 3.5 feet above the seafloor. The gravel bedding dimensions are nominal, as shown in **Figure 1**, and therefore, the port height above the seafloor is not known with high accuracy. Momentum of the effluent is a key factor in determining the dilution within the ZID. Toward the end of the ZID, the plume slows down and mixing is not as strong as at the beginning of the ZID. Therefore, the dilution results are not likely to change by much if the port height is not precisely known and, considering the overall uncertainty in the analysis, it is not critical to determine the diffuser port height with high accuracy. In this analysis, it was assumed that effluent plumes do not interact with the ballast, which is supported by the plume dimensions computed. Details of the current diffuser configuration are summarized in **Table 2**.

¹ Section F, Drawing P-0.03, Contract Documents Volume 1 of 1: Ocean Outfall Contract No. 2.1, January 1982 by Engineering Science for MRWPCA.

Table 2 – Current diffuser configuration.

Parameter	Value
Diffuser length	1368 feet (417 m*)
Depth of diffuser ports	95 to 109 feet below MSL
Number of open ports	120
Port spacing	8 feet (2.44 m*)
Port diameter	2 inches (0.051 m*)
Port exit condition	Tideflex Series 35 4-inch duckbill valves
Port vertical angle	0° (horizontal)
Port elevation above sea floor	3.5 feet (1.07 m*)

*m = meters

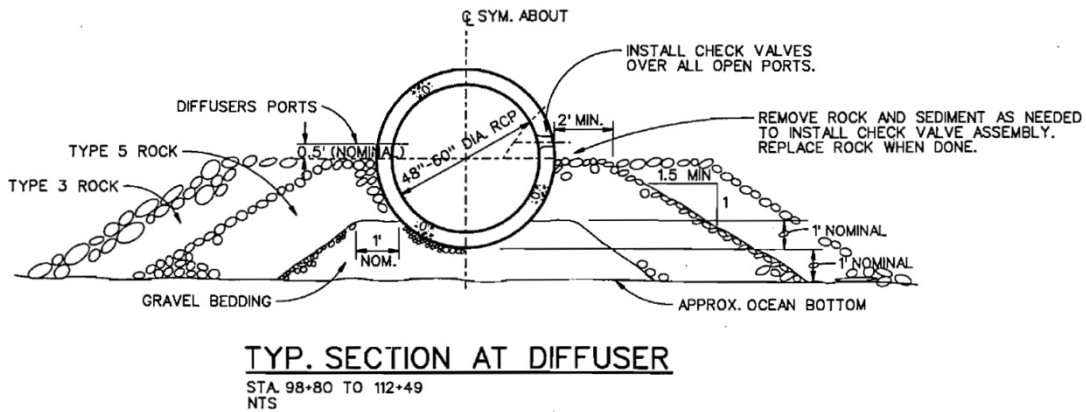
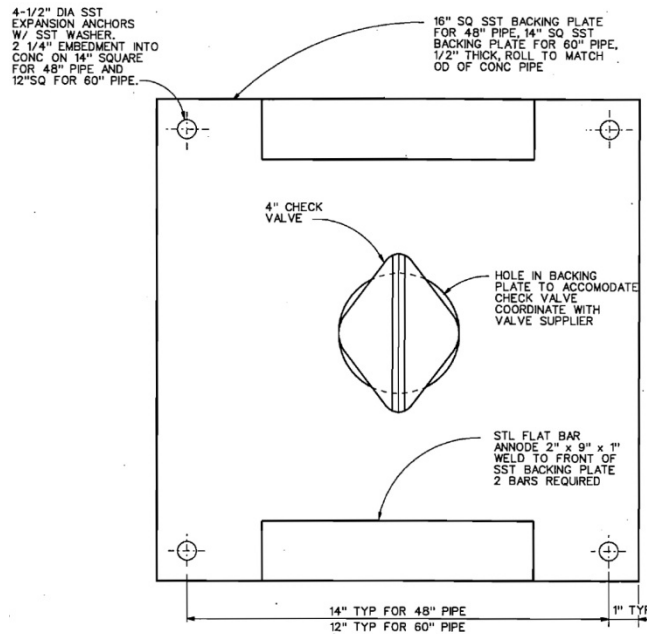

Figure 1. Typical diffuser section (currently in place).

The 120 ports that are currently open are fitted with Tideflex “duckbill” check valves, as shown in **Figure 2**. The shape of the duckbill valve opening is elliptic and the area of the opening depends on the discharge flow rate. The valve opening area in this analysis was determined from an effective open area curve provided by Tideflex Technologies (included as **Appendix A**). Although the ports were modeled as round openings with the same opening area as the “duckbill” valves, because of the oblateness of the actual port opening, the actual dilution will be slightly higher than the dilution computed assuming circular ports. This is because the perimeter of ellipse, which is where the entrainment of diluting water occurs, is larger than that of a circle.



CHECK VALVE END DETAIL
6"-1'-0" FOR 48" DIA PIPE
NTS FOR 60" DIA PIPE

Figure 2. Typical “duckbill” valve detail (shown closed, i.e., with no flow).

Discharge Characteristics

Salinity (or total dissolved solids [TDS]) and temperature data for the brine (Scenarios 1 through 4) and the MRWPCA wastewater (Scenario 3) have been provided by ESA. TDS is a measure of water salinity, and salinity and temperature are used to calculate the density of the effluent and ambient ocean water, which are important parameters in dilution analyses.

As summarized in **Table 1**, ESA selected three seasonal ocean conditions for analysis: Upwelling (July), Davidson (January), and Oceanic (September). Therefore, discharge rate, temperature, and salinity/TDS data for these months, presented in **Table 3**, were used in the analysis. For the combined brine and wastewater flow scenario (Scenario 3), the desalination brine was assumed to be fully mixed with the wastewater. Thus, the temperature and salinity of the combined flow were calculated as the flow-weighted average temperature and salinity of the brine and wastewater.

The analyses completed as part of this study are summarized in **Table 3**. All scenarios were analyzed for zero ocean current velocity conditions, which represent worst-case conditions since any ocean current only increases dilution. Ocean currents increase the amount of dilution that occurs because they increase the flow of ambient water past the diffuser (i.e., increase the amount of ambient water available for mixing with the

discharge). Although ocean currents increase effluent dilution, the California Ocean Plan (State Water Resources Control Board, SWRCB, 2009) requires that the no-current condition should be used in initial dilution calculations.

Table 3 – Summary of analyses for Scenarios 1 through 4.

Scenario	Analysis Number	Effluent Flow (mgd)	Effluent Salinity (ppt*)	Effluent Temp. (°C)	Seasonal Condition	Diffuser Port Angle	Effective Port Diameter (in)
1	1.1	13.98	58.23	9.9	Upwelling (July)	0°	1.86
2	2.1	13.98	57.40	11.6	Davidson (Jan.)	0°	1.86
3	3.1	33.76	24.23	16.5	Davidson (Jan.)	0°	2.29
4	4.1	13.98	57.64	11.1	Oceanic (Sept.)	0°	1.86

* ppt = parts per thousand.

Receiving Water Profiles

ESA provided Flow Science with representative ocean receiving water profile data (temperature and salinity) for the three months corresponding to the selected discharge scenarios (July, January, and September). Receiving water profile data were collected by the Monterey Bay Aquarium Research Institute (MBARI) at station C1 at the head of Monterey Canyon, approximately five miles northwest of the MRWPCA wastewater ocean outfall (see **Figure 3**). This location has been occupied since 1988 by MBARI. Monthly conductivity, temperature, and depth (CTD) profiles have been collected since 2002. The proximity of the location to the MRWPCA ocean outfall and the long data record make this the most appropriate and useful data set to characterize the ambient conditions for the brine discharge analysis. Vertical profiles of temperature and salinity were analyzed for the upper 50 meters of the water column for the years 2002-2012, and a single representative profile was selected for each of the three ocean seasons. For the July model run, temperature and salinity profiles from 2011 were selected. For the September model run, profiles from 2004 were selected. For the January model runs, a temperature profile from 2004 and a salinity profile from 2011 were selected. Profile data are shown in tabular form in **Appendix B**. Maximum and minimum values for each profile are shown in **Table 4**.

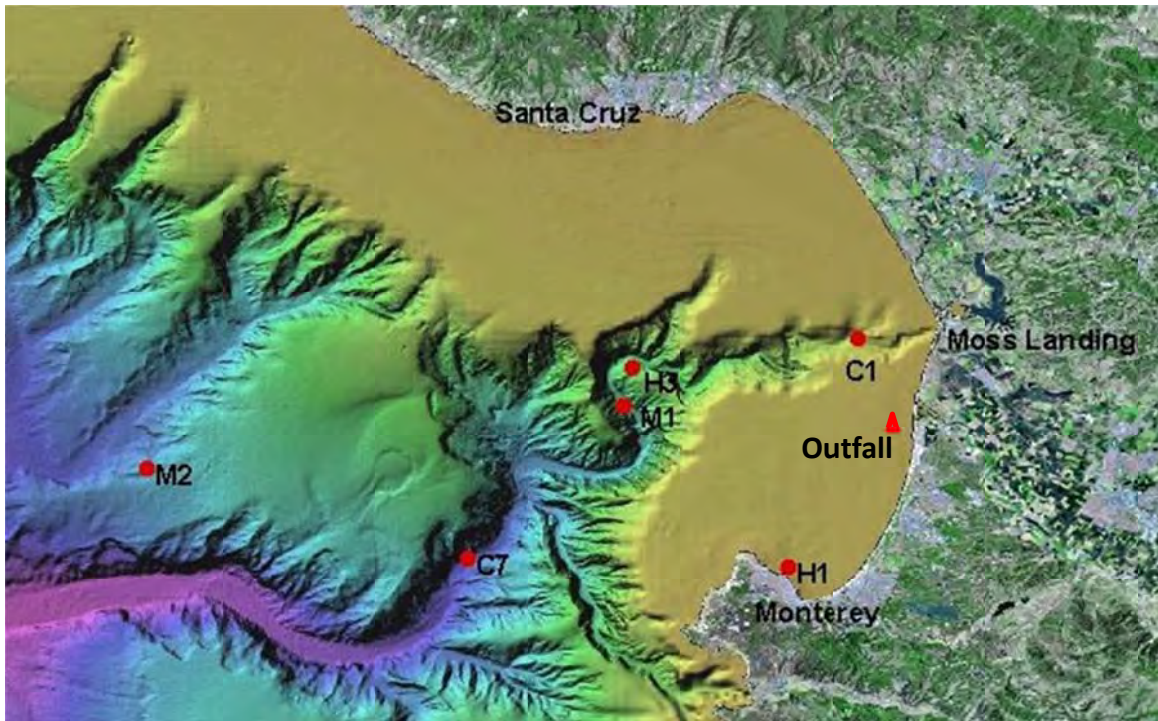

Figure 3. Location map, MBARI ocean monitoring stations and MRWPCA outfall.

Table 4 – Maximum and minimum ocean profile data.

Parameter	Season	Minimum	Maximum
Salinity (ppt)	Upwelling (July)	33.7	33.9
	Davidson (January)	33.2	33.5
	Oceanic (September)	33.5	33.6
Temperature (C°)	Upwelling (July)	10.0	13.0
	Davidson (January)	10.7	12.7
	Oceanic (September)	10.6	15.8

Source: ESA (2013); Appendix B.

Receiving water flow conditions

As detailed in **Figure 1**, the existing diffuser ports are located just above the mid-point of the outfall pipe (i.e., below the crown of the outfall pipe), about 6 inches above the top of the ballast used to anchor the diffuser to the seafloor. Because the outfall rises above the

seafloor, it will influence the patterns of currents (receiving water flow velocity) at the ports, and the current velocity at each individual port will be a complex function of the local geometry. Local field data collection would be required to characterize the actual current conditions at the diffuser ports, which was beyond the scope and budget of this analysis. To simplify the analysis, effluent dilution was analyzed for a uniform 0.0 fps current, which amounts to a “worst case,” stagnant (no current) receiving water condition. Stagnant conditions are typically used as the basis for developing NPDES permits, and the California Ocean Plan (SWRCB, 2009) requires the no-current condition be used in initial dilution calculations.

3. NEGATIVELY BUOYANT PLUME AND ZID

The effluent and ocean profiles data presented in **Tables 3** and **4** indicate the effluent is negatively buoyant for Scenarios 1, 2 and 4. A sketch of the trajectory of a negatively buoyant jet is shown in **Figure 4**, where θ_0 is the port angle, d is the port diameter, s is distance in the direction of the port centerline, n is distance in the direction perpendicular to the port centerline, z_{me} is the maximum rise of the plume, M_0 is the initial momentum flux at the point of discharge, and M_b is the buoyancy-generated momentum flux. The impact point is the location where the plume centerline returns to the port height level, and x_{OR} is the distance between the port and the impact point.

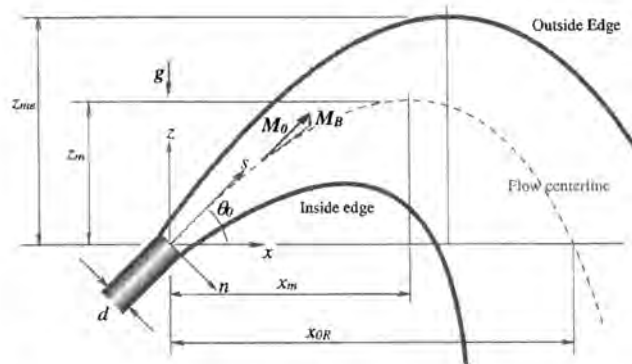

Fig. 1. Schematic diagram of the generic discharge configuration

Figure 4. Definition schematic for negatively buoyant jet (Kikkert, et al., 2007).

The methods described in the next section calculate the size of the plume and dilution of the discharged effluent within the “Zone of Initial Dilution” or ZID. The ZID is defined as the zone immediately adjacent to a discharge where momentum and buoyancy-driven mixing produces rapid dilution of the discharge. In this analysis, the ZID ends at the point where the discharge plume impacts the seafloor for a dense (sinking) plume; and for a positively buoyant (rising) effluent, the ZID ends at the point where the effluent plume reaches the water surface or attains a depth level where the density of the diluted effluent plume becomes the same as the density of ambient water (i.e., the “trap” level).

Typically, within the ZID, which is limited in size, constituent concentrations are permitted to exceed water quality standards. A discharge is generally required to meet the relevant water quality standards at the edge of the ZID.

Beyond the point where the plumes reach the seafloor, some additional mixing will occur, and the discharged brine (now diluted) will travel along the seafloor as a density current. Based on the bathymetry near the diffuser, which steadily slopes out to sea, there is no “bowl” in which effluent could accumulate indefinitely. Rather diluted effluent driven by gravity would flow downslope and gradually disperse. Estimation of the spreading of the plume on the seafloor would require detailed bathymetry data near the diffuser and use of additional analysis methods, such as a three-dimensional model or a physical model of the discharge. Similarly, the analysis of the buoyant (rising) plume within and beyond the “trap” level would require additional analysis methods. In the analysis presented here the spreading of the effluent on the seafloor, or within and beyond the trapping level and the subsequent additional dilution that would ensue, has not been analyzed. Flow Science recommends that the computed dilution at the seafloor, or at the trapping level, (i.e., at the end of the ZID), be used as the basis for any NPDES permitting activities and to analyze impacts.

4. PLUME ANALYSIS METHODS

Two analysis methods have been used to evaluate the discharge of desalination brines (negatively buoyant plumes) from the MRWPCA diffuser: a semi-empirical method based on the work of Roberts et al. (1997) and Kikkert et al. (2007) and EPA’s Visual Plumes method. The Visual Plumes method was also used to model scenarios where the effluent density is less than seawater (positively buoyant, or rising, plumes). Both the semi-empirical method and Visual Plumes were used to characterize negatively buoyant plumes in order to understand the range of dilution that might be expected for discharge from the MRWPCA diffuser system. The semi-empirical method also provides some level of redundancy and confirmation of results because Visual Plumes, although widely used in diffuser discharge analysis, has only very recently been validated against limited experimental data for the case of a negatively buoyant plume. The main advantage of the semi-empirical analysis method is that it is well-grounded in empirical observations, and thus is well-tested and has been verified by comparison to a relatively large dataset for this specific discharge condition. The main disadvantage is that the semi-empirical method requires longer to complete an analysis for a given discharge scenario. The analysis techniques for these two methods are described below.

4.1 Semi-Empirical Analysis Method

Laboratory studies of negatively buoyant jets and plumes have been conducted by many researchers (e.g., Kikkert et al., 2007; Roberts et al., 1997). Most of these have been

conducted for inclined jets (i.e., jets that discharge upward at an angle), which increases the initial mixing of the plume. Fewer studies are available to characterize the mixing of negatively buoyant plumes from horizontally-oriented discharge ports. In the following sections, the general equations for a negatively buoyant jet from an angled port are presented first. The equations for a horizontal discharge are then derived from the general equations.

Discharge of a negatively buoyant jet from an angled port

Plume trajectory

The trajectory of a negatively buoyant discharge under a stagnant flow condition (i.e., no ambient current) can be computed from the following equations (Kikkert, et al., 2007) (see Figure 4 for nomenclature).

$$\frac{dn_*}{ds_*} = \frac{M_{B*} \cos \theta_0}{1 - M_{B*} \sin \theta_0} \quad (1)$$

where:

$$s_* = s / d$$

$$n_* = n / d$$

s and n are the distances in directions along and perpendicular to the discharge port centerline, respectively; d is the effective diameter of the port (see **Figure 4**); and M_{B*} is the dimensionless buoyancy-generated momentum flux, which can be calculated from Eq. (2).

$$M_{B*} = 0.154 \frac{s_*^2}{F_0^2} \quad (2)$$

where F_0 is the initial densimetric Froude number:

$$F_0 = \frac{U_0}{\sqrt{gd(\rho_0 - \rho_a) / \rho_a}}$$

where

U_0 = initial jet velocity

g = gravitational acceleration

ρ_0 = initial density of the jet

ρ_a = ambient water density

Substituting Eq. (2) into Eq. (1) and integrating gives an equation for the discharge trajectory:

$$n_* = \frac{2.6F_0}{\tan \theta_0 \sin^{1/2} \theta_0} \left[-\frac{s_* \sin^{1/2} \theta_0}{2.6F_0} + \frac{1}{2} \ln \left(\frac{2.6F_0 + s_* \sin^{1/2} \theta_0}{2.6F_0 - s_* \sin^{1/2} \theta_0} \right) \right] \quad (3)$$

Results from Eq. (3) agreed well with experimental data (Kikkert, et al., 2007).

Discharge of a negatively buoyant jet from a horizontal port

Plume trajectory

The plume trajectory of a horizontal discharge can be estimated using the equations for an angled jet. Specifically, for a horizontal discharge (i.e., $\theta_0=0$), Eq. (3) simplifies to the following relationship:

$$n_* = 0.051 \frac{s_*^3}{F_0^2} \quad (4)$$

Plume dilution for a horizontal discharge

For the horizontally discharged effluent, the empirical equations from Fischer et al., 1979 (Table 9.2, pp. 328) were used to compute the width and dilution of the effluent. i.e.,

$$\text{Plume width} = 2 * 0.13 * \text{distance along plume} \quad (5)$$

The plume width calculated from Eq. (5) defines the edge of the plume as the location where the concentration is 37% ($= e^{-1}$, which is often used to characterize plume width) of the centerline concentration.

The volume flux and dilution are specified by:

$$\text{Volume flux } \mu = 0.25M^{1/2} * \text{distance along plume} \quad (6)$$

$$\text{Dilution} = \mu / (\text{discharge flow rate}) \quad (7)$$

where $M=QU_0$ is the initial momentum flux of the effluent (Q and U_0 are the flow rate and initial velocity of the effluent, respectively).

Note that the semi-empirical analysis uses Kikkert for the trajectory and Fischer for dilution for 0° discharges.

4.2 Visual Plumes Analysis Method

Methodology

The UM3 model—part of the EPA Visual Plumes diffuser modeling package—was used to simulate the discharge of desalination brine and wastewater from the existing MRWPCA ocean diffuser. Visual Plumes is a mixing zone computer model developed from a joint effort led by US EPA. Visual Plumes can simulate both single and merging submerged plumes, and stratified ambient flow can be specified by the user. Visual Plumes can be used to compute the plume dilution, trajectory, diameter, and other plume variables (US EPA, 2003).

The UM3 model is based on the projected area entrainment hypothesis, which assumes ambient fluid is entrained into the plume through areas projected in directions along the plume centerline and perpendicular to the centerline (US EPA, 1994). In addition, shear entrainment is included. The plume envelope is assumed to be in steady state, and as a plume element moves through the envelope, the element radius changes in response to velocity convergence or divergence, and entrainment of ambient fluid. Conservation equations of mass, momentum and energy are used to calculate plume mass and concentrations.

The actual depth of the diffuser ports varies between 95 and 109 feet below mean sea level (MSL) since the diffuser is quite long and is situated on a sloping portion of the ocean floor. However, since Visual Plumes cannot model a sloping diffuser, an average depth of 104 feet below MSL was used (the deepest 120 ports on the diffuser are assumed to discharge in this case, thereby increasing the average port depth). Modeled ocean conditions are summarized in **Table 5**.

As with the semi-empirical method, Visual Plumes assumes circular discharge ports, so the actual elliptical discharge area was calculated for each port (**Appendix A**) and then converted to an effective circular discharge diameter for use in Visual Plumes.

A study by Palomar et al. (2012a, 2012b) showed that the UM3 model of the Visual Plumes can be applied to simulate negatively buoyant discharges. However, the study also showed that the UM3 model underpredicted centerline dilution ratios at the impact point by more than 50% for a negatively buoyant effluent discharged into a stagnant environment; for a number of scenarios with negatively buoyant effluent discharged into an ambient current, centerline dilution ratios at the impact point calculated by the UM3 model ranged from 40% lower to 7% higher than experimental data. The UM3 model of the Visual Plumes was used in this analysis to model negatively buoyant effluent discharged into a stagnant environment. As noted, the study of Palomar et al. (2012a, 2012b) has shown that the centerline dilution ratios computed using the UM3 model were

more than 50% lower than data from experiments with similar discharge conditions. For this reason, the average dilution ratios calculated using UM3, which are nearly double the centerline dilution ratios, were used to estimate dilution of negatively buoyant plumes in this analysis. Since Visual Plumes has been more thoroughly validated for positively buoyant plumes, it alone was used for scenarios with rising plumes.

Table 5 – Visual Plumes modeled seasonal ocean conditions.

Depth (m)	Upwelling (July)		Davidson (January)		Oceanic (September)	
	Temp. (°C)	Salinity (ppt)	Temp. (°C)	Salinity (ppt)	Temp. (°C)	Salinity (ppt)
0	12.98	33.78	12.65	33.20	15.75	33.46
2	12.87	33.77	12.65	33.22	15.75	33.46
4	12.64	33.74	12.65	33.22	15.75	33.46
6	11.97	33.71	12.65	33.23	15.53	33.46
8	11.61	33.70	12.74	33.24	14.46	33.46
10	11.34	33.70	12.57	33.26	13.81	33.46
12	11.10	33.73	12.50	33.28	13.17	33.46
14	10.84	33.75	12.42	33.30	12.27	33.46
16	10.51	33.78	12.33	33.30	11.83	33.46
18	10.38	33.79	12.24	33.30	11.52	33.46
20	10.38	33.80	12.22	33.28	11.19	33.46
22	10.38	33.80	12.07	33.30	11.06	33.46
24	10.38	33.82	12.05	33.30	11.22	33.49
26	10.38	33.82	11.90	33.30	11.39	33.50
28	10.38	33.84	11.81	33.32	11.39	33.50
30	10.38	33.84	11.71	33.34	11.31	33.50
32	10.37	33.84	11.71	33.37	11.23	33.50
34	10.31	33.84	11.63	33.39	11.22	33.50
36	10.30	33.84	11.63	33.42	11.05	33.50
38	10.30	33.84	11.54	33.43	10.97	33.50

Source: Interpolated from ESA | Water (2013) ocean profile data, Appendix B.

5. DILUTION RESULTS

Several key results for the effluent plumes are reported at the edge of the ZID. As noted above, the ZID is defined as the zone immediately adjacent to a discharge where momentum and buoyancy-driven mixing produces rapid dilution of the discharge. Results for positively buoyant plumes presented in this Technical Memorandum were taken at the point where the plumes just reached the trap level, which is the depth level where the density of the diluted plume becomes the same as ambient seawater. Horizontal spreading of plumes at their trap levels was not included in this analysis. Results from each scenario generally include the following quantities:

- the horizontal distance from the diffuser port to the point at which the plume impacts the seafloor or reaches the trap level
- the dilution of the plume at the point at which the plume impacts the seafloor or reaches the trap level; for the semi-empirical method and the Visual Plumes analyses of rising plumes, centerline dilution is provided, while for the Visual Plumes analyses of negatively buoyant discharges, the average dilution within the plume is provided, in recognition of the conservative nature of Visual Plumes results for negatively buoyant plumes (see, e.g., Palomar et al., 2012a and 2012b)
- an estimate of the size of the plume (diameter) at the point of impact or just below the trap level (i.e., at the edge of the ZID)
- the maximum salinity at the seafloor (edge of ZID for negatively buoyant plumes)
- the percentage by which the maximum plume salinity at the seafloor (edge of ZID for negatively buoyant plumes) exceeds the ambient salinity.

Figure 5 shows a sample schematic graphic of the trajectory of a negatively buoyant plume from a horizontal discharge drawn approximately to scale. As the effluent travels away from the discharge port, it entrains ambient seawater, which increases the diameter of the plume and decreases the plume concentration.

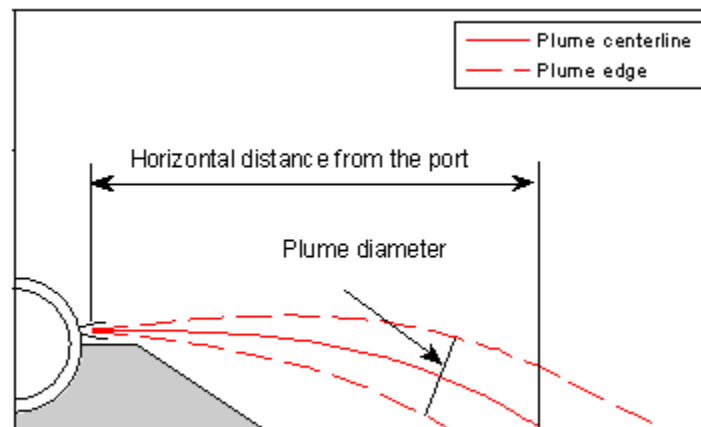

Figure 5. Sample graphic showing plume trajectory for the horizontal discharge configuration.

Table 6 presents analysis results for the four modeled scenarios. The plume in analysis 3.1 was positively buoyant (i.e., had discharge densities less than ambient seawater). This is because the plume in this analysis was a mixture of desalination brine and relatively significant amounts of comparatively non-saline (i.e., “fresh”) wastewater effluent. For all other analyses the plumes were negatively buoyant (i.e., water denser than ambient seawater is discharged) since they consisted only of desalination brine,

which is more dense than regular seawater. Results in **Table 6** show that the trajectory, diameter and dilution of the negatively buoyant plumes were nearly the same across all three modeled seasons, because the trajectories of these negatively buoyant plumes were short and close to the seafloor, where the differences in salinity and temperature (hence the difference in density) between the effluent and ambient sea water changed only slightly over the modeled seasons. Therefore for brine only cases, characteristics of the resulting plumes were nearly the same for the three modeled scenarios.

Dilution values predicted by the semi-empirical method were lower than the dilution values predicted by the Visual Plumes method. The predicted maximum plume salinity at the seafloor was 1.5 ppt above ambient ocean salinity.

Figures 6 and **7** illustrate the trajectory and shape of the negatively buoyant plume computed from Visual Plumes for Analysis 1.1 (as listed in **Table 3** and **Table 6**). **Figure 8** is an illustration of positively buoyant plumes just reaching the trap level, as computed from Visual Plumes for Analysis 3.1. Spreading of the plume within and beyond the trap level is not shown. Plumes computed for other scenarios have similar trajectories and shape as shown in these figures.



Table 6– Analysis results.

Analysis number	Effluent discharge flow rate (mgd)	Discharge Velocity (feet/second)	Seasonal Condition	Diffuser port angle (θ _o)	Effluent salinity (ppt)	Ocean bkgd. salinity at diffuser depth (ppt)	Semi-empirical method						VP method					
							Plume diam. (d) (inch)	Center-line Dilution	Horiz. Distance from port (ft)	Max. height above port (z _{me}) (ft)	Plume salinity at calc. dilution (ppt)	Salinity increase above ambient (ppt)	Plume diam. (inch)	Average Dilution	Horiz. Distance from port (ft)	Max. height above port (z _{me}) (ft)	Plume salinity at calc. dilution (ppt)	Salinity increase above ambient (ppt)
1.1	13.98	9.5	Upwelling (July)	0°	58.23	33.84	36	16	12	--	35.36	1.5	42	25	8.6	--	34.82	1.0
2.1	13.98	9.5	Davidson (Jan.)	0°	57.40	33.36	37	16	12	--	34.83	1.5	42	25	8.7	--	34.30	0.9
3.1	33.76	15.2	Davidson (Jan.)	0°	24.23	33.36	--	--	--	--	--	--	230	68 ^a	47	32 ^b	--	--
4.1	13.98	9.5	Oceanic (Sept.)	0°	57.64	33.50	35	16	12	--	35.01	1.5	42	25	8.7	--	34.47	1.0

Source: Flow Science Analysis, 2014.

^a For Analysis 3.1, the dilution value is centerline dilution because the Visual Plumes model has been validated for positively buoyant plumes and no significant underprediction of dilution has been reported.

^b These values are trap levels above the diffuser.

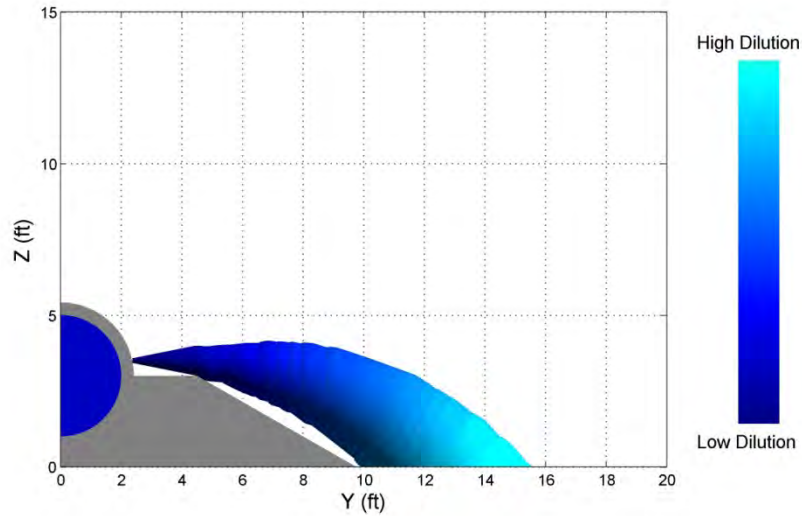

Figure 6. Analysis 1.1 (13.98 mgd, 58.23 ppt), plume computed from VP. Minimum dilution at seafloor is 25 (maximum salinity of 34.82 ppt).

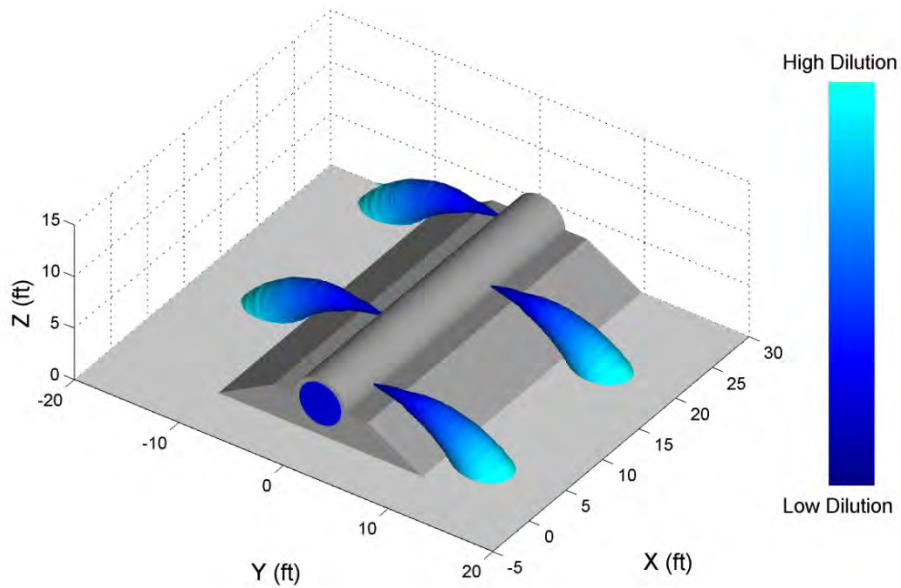
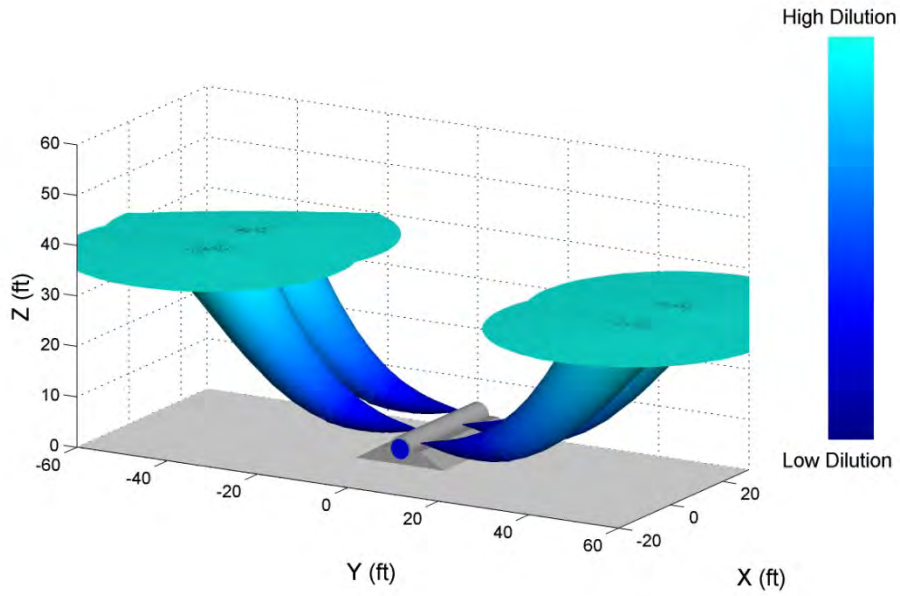

Figure 7. Analysis 1.1 (13.98 mgd, 58.23 ppt), plume computed from VP (3D view, only 4 ports are shown). Minimum dilution at seafloor is 25 (maximum salinity of 34.82 ppt).



**Figure 8. An illustration of the positively buoyant effluent plumes of Analysis 3.1.
Note that only four diffuser ports are illustrated.**

5. REFERENCES

- Fischer, H.B., List, E. J., Koh, R. C. Y., Imberger, J. Brooks, N. H. (1979) *Mixing in Inland and Coastal Waters*, Academic Press, 483 pp.
- Kikkert, G.A.; Davidson, J.; and Nokes, R.I. (2007). *Inclined Negatively Buoyant Discharges*. *Journal of Hydraulic Engineering*, 133(5), pp545-554.
- Palomar, P., Lara, J.L., Losada, I.J., Rodrigo, M., and Álvarez, A. (2012a). *Near Field Brine Discharge Modelling Part 1: Analysis of Commercial Tools*. *Desalination* 290, pp14-27.
- Palomar, P., Lara, J.L., Losada, I.J., Rodrigo, M., and Álvarez, A. (2012b). *Near Field Brine Discharge Modelling Part 2: Validation of Commercial Tools*. *Desalination* 290, pp28-42.
- Roberts, P. J.W.; Ferrier, A.; and Daviero, G. (1997). *Mixing in Inclined Dense Jets*. *Journal of Hydraulic Engineering*, 123(8), pp693-699.
- State Water Resources Control Board (2009). *California Ocean Plan, Water Quality Control Plan for Ocean Waters of California*.
- US EPA (1994). *Dilution Models for Effluent Discharges (3rd edition)*. EPA/600/R-94/086, June, 1994.
- US EPA (2003). *Dilution Models for Effluent Discharges (4th edition)*. EPA/600/R-03/025, March, 2003.

APPENDIX A – DUCKBILL VALVE, EFFECTIVE OPEN AREA

4" Tideflex TF-2, 35, TF-1, 35-1, 39 Effective Open Area vs. Flow

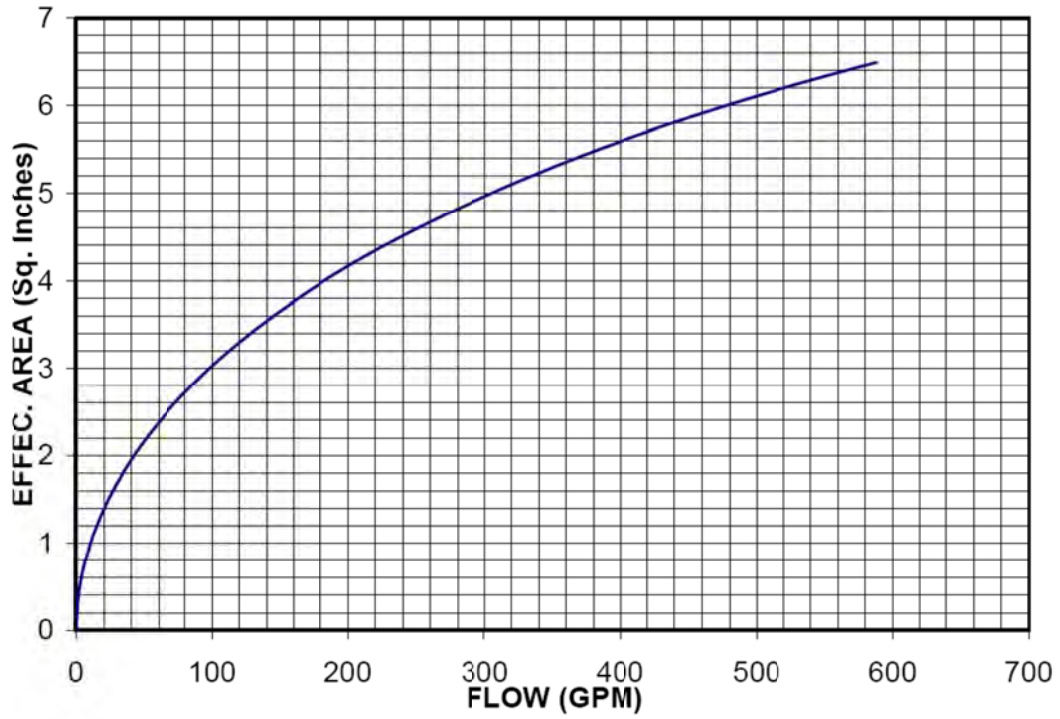

Chart provided by Tideflex Technologies.

APPENDIX B – AMBIENT OCEAN PROFILE DATA

**Table B1- Ambient ocean profile data, MBARI station C1
(Source: ESA)**

Upwelling (July)				Transition-Oceanic (Sept)				Davidson (Jan)			
2011 Profile		2011 Profile		2004.2 Profile		2004.1 Profile		2011 Profile		2004 Profile	
S (ppt)	Z (m)	T (°C)	Z (m)	S (ppt)	Z (m)	T (°C)	Z (m)	S (ppt)	Z (m)	T (°C)	Z (m)
33.78	-0.93	12.98	-0.59	33.46	-3.30	15.83	-4.22	33.20	-0.41	12.65	-2.35
33.76	-1.97	12.91	-1.63	33.46	-4.29	15.66	-4.22	33.22	-0.40	12.65	-2.35
33.78	-1.98	12.84	-2.68	33.46	-5.28	15.66	-5.22	33.22	-1.44	12.65	-3.34
33.78	-3.03	12.77	-2.68	33.46	-6.28	15.75	-6.21	33.22	-2.47	12.65	-4.33
33.76	-4.06	12.77	-3.73	33.46	-7.27	15.83	-6.21	33.22	-3.51	12.65	-5.32
33.74	-4.05	12.70	-3.73	33.46	-8.27	15.75	-6.21	33.22	-4.54	12.65	-6.31
33.72	-4.04	12.63	-4.78	33.46	-9.26	15.66	-6.21	33.22	-5.57	12.65	-7.30
33.74	-5.10	12.56	-4.78	33.46	-10.25	15.23	-6.21	33.22	-6.61	12.74	-7.30
33.72	-5.09	12.35	-4.80	33.46	-11.25	15.15	-6.21	33.24	-6.60	12.74	-8.29
33.70	-6.13	12.28	-4.80	33.46	-12.24	15.06	-6.21	33.24	-7.63	12.65	-8.29
33.70	-7.17	12.21	-4.80	33.46	-13.23	14.98	-7.21	33.26	-8.65	12.57	-9.29
33.70	-8.22	12.14	-4.81	33.46	-14.23	14.89	-7.21	33.26	-9.69	12.57	-10.28
33.70	-9.27	12.07	-5.85	33.46	-15.22	14.81	-7.21	33.28	-10.71	12.57	-11.27
33.70	-10.32	12.00	-5.86	33.46	-16.22	14.72	-7.21	33.28	-11.74	12.48	-12.27
33.72	-11.37	11.93	-5.86	33.46	-17.21	14.64	-7.21	33.30	-12.77	12.48	-13.26
33.74	-12.43	11.86	-6.91	33.46	-18.20	14.55	-7.21	33.30	-13.80	12.39	-14.26
33.74	-13.48	11.79	-6.91	33.46	-19.20	14.47	-8.20	33.30	-14.83	12.39	-15.25
33.74	-14.52	11.72	-6.92	33.46	-20.19	14.38	-8.20	33.30	-15.87	12.31	-16.24
33.76	-14.53	11.65	-7.97	33.46	-21.18	14.30	-8.20	33.30	-16.90	12.31	-17.23
33.78	-15.59	11.58	-7.97	33.46	-22.18	14.21	-9.19	33.30	-17.93	12.22	-18.23
33.78	-16.64	11.51	-9.02	33.46	-23.17	14.12	-9.19	33.30	-18.97	12.22	-19.22
33.78	-17.69	11.44	-9.02	33.50	-24.16	14.04	-9.19	33.28	-20.01	12.22	-20.21
33.80	-18.74	11.36	-10.07	33.50	-25.16	13.95	-9.19	33.28	-21.05	12.14	-21.21
33.80	-19.79	11.29	-10.07	33.50	-26.15	13.87	-10.19	33.30	-22.07	12.05	-22.20
33.80	-20.84	11.29	-11.11	33.50	-27.14	13.78	-10.19	33.30	-23.10	12.05	-23.19
33.80	-21.89	11.22	-11.12	33.50	-28.14	13.70	-10.19	33.30	-24.14	12.05	-24.19
33.80	-22.93	11.15	-11.12	33.50	-29.13	13.61	-10.19	33.30	-25.17	11.97	-25.18
33.82	-23.99	11.08	-11.13	33.50	-30.12	13.53	-11.18	33.30	-26.20	11.88	-26.18
33.82	-25.04	11.08	-12.17	33.50	-31.12	13.44	-11.18	33.32	-27.23	11.88	-27.17
33.82	-26.08	11.01	-13.22	33.50	-32.11	13.36	-12.17	33.32	-28.26	11.80	-28.16
33.82	-27.13	10.94	-13.22	33.50	-33.11	13.27	-12.17	33.34	-29.28	11.80	-29.16
33.84	-28.19	10.87	-13.22	33.50	-34.10	13.19	-12.17	33.34	-30.32	11.71	-29.16
33.84	-29.24	10.80	-14.27	33.50	-35.09	13.10	-12.17	33.36	-31.34	11.71	-30.15
33.84	-30.28	10.73	-15.32	33.50	-36.09	13.02	-12.17	33.38	-32.36	11.71	-31.14
33.84	-31.33	10.66	-15.32	33.50	-37.08	12.93	-12.17	33.38	-33.40	11.71	-32.13
33.84	-32.38	10.59	-15.33	33.50	-38.07	12.85	-12.17	33.40	-34.42	11.63	-33.13
33.84	-33.42	10.52	-15.33	33.50	-39.07	12.76	-13.17	33.42	-35.44	11.63	-34.12
33.84	-34.47	10.45	-16.38	33.50	-40.06	12.67	-13.17	33.42	-36.48	11.63	-35.11
33.84	-35.52	10.38	-17.42	33.50	-41.06	12.59	-13.17	33.42	-37.51	11.63	-36.10
33.84	-36.57	10.38	-18.46	33.50	-42.05	12.50	-13.17	33.44	-38.53	11.54	-37.10
33.84	-37.61	10.38	-19.51	33.50	-43.04	12.42	-13.17	33.44	-39.57	11.54	-38.09
33.84	-38.66	10.38	-20.55	33.54	-44.03	12.33	-14.16	33.44	-40.60	11.46	-39.09
33.84	-39.71	10.38	-21.59	33.54	-45.03	12.25	-14.16	33.44	-41.64	11.37	-40.08
33.84	-40.75	10.38	-22.63	33.54	-46.02	12.16	-14.16	33.46	-42.66	11.29	-41.08
33.84	-41.80	10.38	-23.67	33.54	-47.01	12.08	-14.16	33.46	-43.69	11.20	-42.07
33.84	-42.85	10.38	-24.71	33.54	-48.01	11.99	-15.16	33.46	-44.73	11.20	-43.06
33.84	-43.90	10.38	-25.76	33.57	-49.00	11.91	-15.16	33.46	-45.76	11.20	-44.05
33.84	-44.94	10.38	-26.80	33.57	-49.99	11.82	-15.16	33.46	-46.79	11.12	-45.05

Table B1 (continued)

Upwelling (July)				Transition-Oceanic (Sept)				Davidson (Jan)			
2011 Profile		2011 Profile		2004.2 Profile		2004.1 Profile		2011 Profile		2004 Profile	
S (ppt)	Z (m)	T (°C)	Z (m)	S (ppt)	Z (m)	T (°C)	Z (m)	S (ppt)	Z (m)	T (°C)	Z (m)
33.84	-45.99	10.38	-27.84			11.82	-16.15	33.48	-47.82	11.03	-46.05
33.86	-47.05	10.38	-28.88			11.74	-17.14	33.50	-48.84	11.03	-47.04
33.86	-48.09	10.38	-29.92			11.65	-18.14	33.50	-49.87	10.95	-48.03
33.86	-49.14	10.38	-30.97			11.57	-18.14	33.51	-50.90	10.86	-49.03
33.86	-50.19	10.37	-32.01			11.48	-18.14	33.51	-51.93	10.86	-50.02
33.86	-51.23	10.37	-33.05			11.39	-18.14	33.53	-52.95	10.77	-51.01
33.86	-52.28	10.30	-34.09			11.31	-18.14	33.53	-53.99	10.77	-52.01
		10.30	-35.14			11.22	-19.13			10.77	-53.00
		10.30	-36.18			11.22	-20.12			10.69	-53.99
		10.30	-37.22			11.14	-20.12			10.69	-54.98
		10.30	-38.26			11.14	-21.12				
		10.30	-39.30			11.05	-21.12				
		10.30	-40.34			11.05	-22.11				
		10.30	-41.39			11.14	-23.11				
		10.30	-42.43			11.22	-24.10				
		10.23	-43.47			11.31	-25.09				
		10.23	-44.52			11.39	-26.09				
		10.16	-45.56			11.39	-27.08				
		10.16	-46.60			11.39	-28.07				
		10.16	-47.65			11.39	-29.07				
		10.09	-48.69			11.31	-30.06				
		10.09	-49.73			11.31	-31.06				
		10.09	-50.78			11.22	-32.05				
		10.02	-51.82			11.22	-33.04				
						11.22	-34.04				
						11.14	-35.03				
						11.05	-36.02				
						11.05	-37.02				
						10.97	-38.01				
						10.88	-39.01				
						10.88	-40.00				
						10.88	-40.99				
						10.88	-41.99				
						10.80	-42.98				
						10.79	-43.98				
						10.79	-44.97				
						10.71	-45.96				
						10.71	-46.96				
						10.62	-47.95				
						10.62	-48.94				
						10.62	-49.94				
						10.62	-50.93				
						10.62	-51.93				
						10.62	-52.92				
						10.62	-53.91				

APPENDIX C – ANALYSES FOR ADDITIONAL SCENARIOS

TECHNICAL MEMORANDUM

DATE: August 25, 2014

TO: Environmental Science Associates (ESA)

FROM: Gang Zhao, Ph.D., P.E., Aaron Mead, P.E., E. John List, Ph.D., P.E.

SUBJECT: **MRWPCA Brine Discharge Diffuser Analysis – Additional Scenarios
FSI 134032**

1. INTRODUCTION

In August 2014, Flow Science performed additional modeling analyses to evaluate the dilution of the desalination brines that may be generated in the future from two primary sources (the proposed Monterey desalination facility and the Groundwater Replenishment Project (GWR Project)). A mixture of brines from these two sources was also evaluated. Specifically, Flow Science modeled thirteen (13) additional discharge scenarios; calculated the desalination brine discharge rate that would be required to achieve a mixed salinity that would be at most 2 ppt above ambient salinity at the seafloor; and calculated the amount of seawater or treated wastewater that would be required to pre-dilute the desalination brine such that the mixed effluent would cause an increase of no more than 2 ppt above ambient salinity at the seafloor. Dilution analyses were conducted using both a semi-empirical method and USEPA's Visual Plumes suite of models, and dilution was evaluated for three seasonal conditions [Davidson current (January), Upwelling conditions (July), and Oceanic conditions (September)]. These analyses are part of the EIR preparation process for the planned Monterey Peninsula Water Supply Project, and the discharge scenarios presented in this Technical Memorandum supplement the discharge scenarios analyzed by Flow Science and presented in a previous Technical Memorandum (Flow Science 2014).

This Technical Memorandum (TM) describes the input data and the analysis methodology used by Flow Science to evaluate the dilution of desalination brines and summarizes the results of the dilution analyses.

2. ANALYSIS INPUT DATA

Discharge Scenarios

In August 2014, Flow Science performed additional analyses for the Monterey Peninsula Water Supply Project. The three tasks that made up these additional modeling analyses are summarized below.

Task 1. Model 13 additional discharge scenarios as specified in ESA’s e-mail of October 10, 2013 and presented in **Table C1** below.

Task 2. Calculate the desalination brine discharge rate required to achieve a mixed salinity that is less than 2 ppt above ambient salinity at the impact point for the three seasonal conditions summarized in **Table C3**. No pre-dilution of the desalination brine was assumed for this task. A series of discharge rates were analyzed to determine the discharge rate required to keep the effluent salinity less than 2 ppt above ambient salinity.

Task 3. Calculate the amount of pre-dilution required for the desalination brine to achieve the less than 2 ppt salinity exceedance at the impact point for the mixed effluent. For this task, it was assumed that ambient seawater or treated wastewater would be used to pre-dilute the desalination brine before discharging to the outfall. A flow rate of 13.98 mgd was used for the desalination brine. Properties of the seawater and wastewater used to pre-dilute the brine are summarized in **Table C3**.

Table C1 – Discharge scenarios

Discharge Condition	Ambient Condition & Effluent Component ^{a,b}	Scenario Number	Discharge (mgd) ^c	Discharge Salinity (ppt) ^d	Discharge Temperature (°C)
Existing	Davidson (Jan) WW	0.0	19.78	0.8	20.0
Desal Project Only	Upwelling (July) BR	5.1	8.99	58.23	9.9
	Davidson (Jan) BR	6.1	8.99	57.40	11.6
	Davidson (Jan) BR+WW	7.1	28.77	18.48	17.4
	Oceanic (Sept) BR	8.1	8.99	57.64	11.1
Desal Project	Upwelling (July) BR+GWR	9.1	9.72	54.16	11.0

Discharge Condition	Ambient Condition & Effluent Component ^{a,b}	Scenario Number	Discharge (mgd) ^c	Discharge Salinity (ppt) ^d	Discharge Temperature (°C)
with GWR	Davidson (Jan) BR+GWR	10.1	9.72	53.39	12.2
	Davidson (Jan) + BR+GWR+WW	11.1	25.64	20.73	17.1
	Oceanic (Sept) BR+GWR	12.1	9.72	53.61	12.1
GWR Only	Upwelling (July) GWR	13.1	0.73	4	24.4
	Davidson (Jan) GWR	14.1	0.73	4	20.2
	Davidson (Jan) GWR+WW	15.1	16.65	0.93	20.0
	Oceanic (Sept) GWR	16.1	0.73	4	24.4

^a BR: desalination brine. WW: wastewater. GWR: Monterey Peninsula Groundwater Replenishment Project.

^b Salinity and temperature of the combined discharges were calculated as flow-weighted averages of BR, WW and GWR salinity and temperature data provided by ESA.

^c mgd: million gallons per day.

^d ppt: part per thousand.

Diffuser Configuration

The existing MRWPCA diffuser has 172 ports. Half of the ports discharge horizontally from one side of the diffuser and half discharge horizontally from the other side of the diffuser, in an alternating pattern. The ports are approximately 6 inches above the rock bedding of the diffuser pipeline, and drawings² (see **Figure C1**) indicate that they are located a minimum of approximately 3.5 feet above the seafloor. The gravel bedding dimensions are nominal, as shown in **Figure C1**, and therefore, the port height above the seafloor cannot be determined with high accuracy. Momentum of the effluent is a key factor in determining the dilution within the ZID. Toward the end of the ZID, the plume slows down and mixing is not as strong as at the beginning of the ZID. Therefore, the dilution results are not likely to change by much if the port height is off slightly. Considering the overall uncertainty in the analysis, it is not critical to determine the diffuser port height with high accuracy. According to MRWPCA, the fifty-two (52) ports nearest to the shore (i.e., the shallowest ports) are currently closed. In this analysis, Flow

² Section F, Drawing P-0.03, Contract Documents Volume 1 of 1: Ocean Outfall Contract No. 2.1, January 1982 by Engineering Science for MRWPCA

Science calculated plume concentrations for effluent discharged horizontally through the 120 open ports. A typical section of the current diffuser is shown in **Figure C1**, although the actual cross-sectional profile of the pipe type 3 rock may have changed over time. In this analysis, it was assumed that effluent plumes do not interact with the ballast. Details of the current diffuser configuration are summarized in **Table C2**.

Table C2 – Current diffuser configuration.

Parameter	Value
Diffuser length	1368 feet (417 m*)
Depth of diffuser ports	95 to 109 feet below MSL
Number of open ports	120
Port spacing	8 feet (2.44 m*)
Port diameter	2 inches (0.051 m*)
Port exit condition	Tideflex Series 35 4-inch duckbill valves
Port vertical angle	0° (horizontal)
Port elevation above sea floor	3.5 feet (1.07 m*)

*m = meters

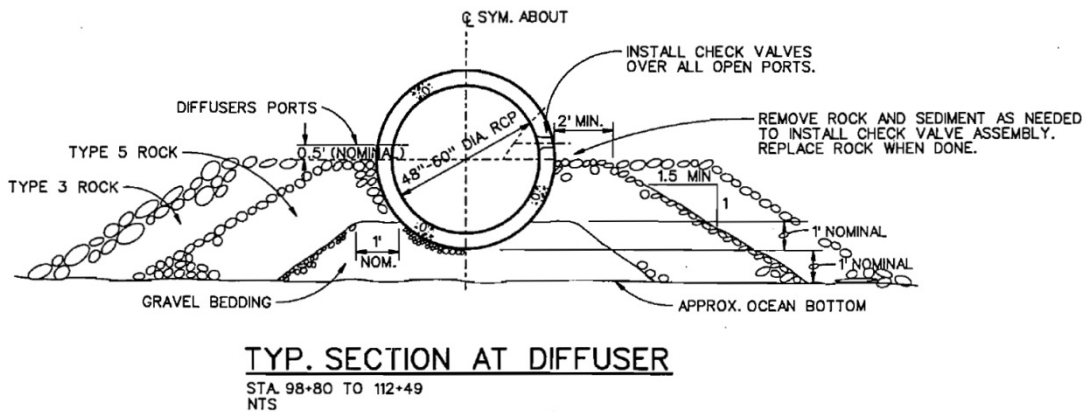
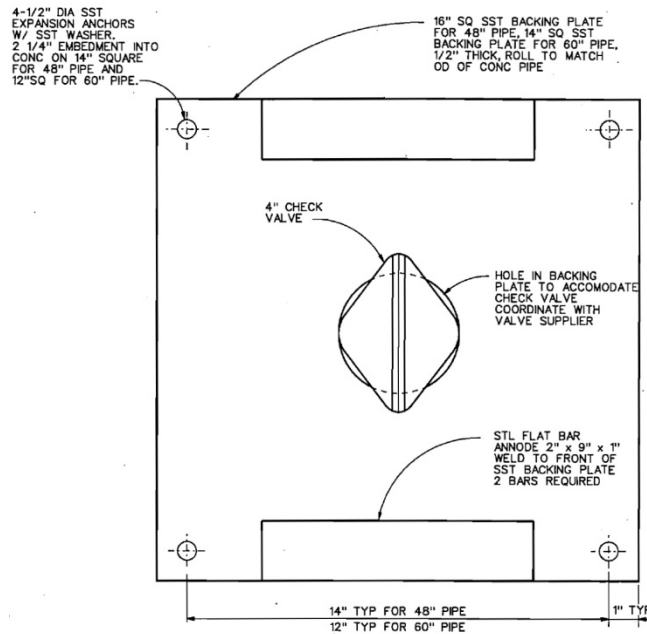

Figure C1. Typical diffuser section (currently in place).

The 120 ports that are currently open are fitted with Tideflex “duckbill” check valves, as shown in **Figure C2**. The shape of the duckbill valve opening is elliptic, and the area of the opening depends on the discharge flow rate. The valve opening area in this analysis was determined from an effective open area curve provided by Tideflex Technologies (included as **Appendix A**). Although the ports were modeled as round openings with the same opening area as the “duckbill” valves, the actual dilution will be higher than the dilution computed assuming circular ports because of the oblateness of the actual port opening.



CHECK VALVE END DETAIL

6"-1'-0" FOR 48" DIA PIPE
NTS FOR 60" DIA PIPE

Figure C2. Typical “duckbill” valve detail (shown closed, i.e., with no flow).

Discharge Characteristics

Salinity (or total dissolved solids [TDS]) and temperature data for the brine, GWR concentrate, ambient seawater and the MRWPCA wastewater were provided by ESA. TDS is a measure of water salinity, and salinity and temperature are used to calculate the density of the effluent and ambient ocean water, which are important parameters in dilution analyses.

As summarized in **Table C3** below, ESA selected three seasonal ocean conditions for analysis: Upwelling (July), Davidson (January), and Oceanic (September). Therefore, discharge rate, temperature, and salinity/TDS data for these months were used in the analysis. For each discharge scenario, the desalination brine(s) and water from other sources were assumed to be fully mixed prior to discharge from the diffuser. Thus, the temperature and salinity of the combined flow were calculated as the flow-weighted average temperature and salinity of the brine and wastewater.

Table C3 – Three seasonal conditions of the desalination brine

Effluent Discharge Season	Brine		Pre-dilution Seawater		Wastewater	
	Salinity (ppt)	Temp. (C°)	Salinity (ppt)	Temp. (C°)	Salinity (ppt)	Temp. (C°)
July (Upwelling)	58.23	9.9	33.8	9.9	0.8	24
January (Davidson)	57.40	11.6	33.4	11.6	0.8	20
September (Oceanic)	57.64	11.1	33.5	11.1	0.9	24

Source: average values provided by ESA.

Receiving Water Profiles

ESA provided Flow Science with representative ocean receiving water profile data (temperature and salinity) for the three months corresponding to the selected discharge scenarios (July, January, and September). Receiving water profile data were collected by the Monterey Bay Aquarium Research Institute (MBARI) at Station C1 at the head of Monterey Canyon, approximately five miles northwest of the MRWPCA wastewater ocean outfall (see **Figure C3**). This location has been occupied since 1988 by MBARI. Monthly conductivity, temperature, and depth (CTD) profiles have been collected since 2002. The proximity of the location to the MRWPCA ocean outfall and the extended data record make this the most appropriate and useful data set to characterize the ambient conditions for the brine discharge analysis. Vertical profiles of temperature and salinity were analyzed for the upper 50 meters of the water column for the years 2002-2012, and a single representative profile was selected for each of the three ocean seasons. For the July model runs, temperature and salinity profiles from 2011 were selected. For the September model runs, profiles from 2004 were selected. For the January model runs, a temperature profile from 2004 and a salinity profile from 2011 were selected. Profile data are shown in tabular form in **Appendix B**. Maximum and minimum values for each profile are shown in **Table C4**, and profile values used in this analysis for the three seasonal conditions are shown in **Table C5**.

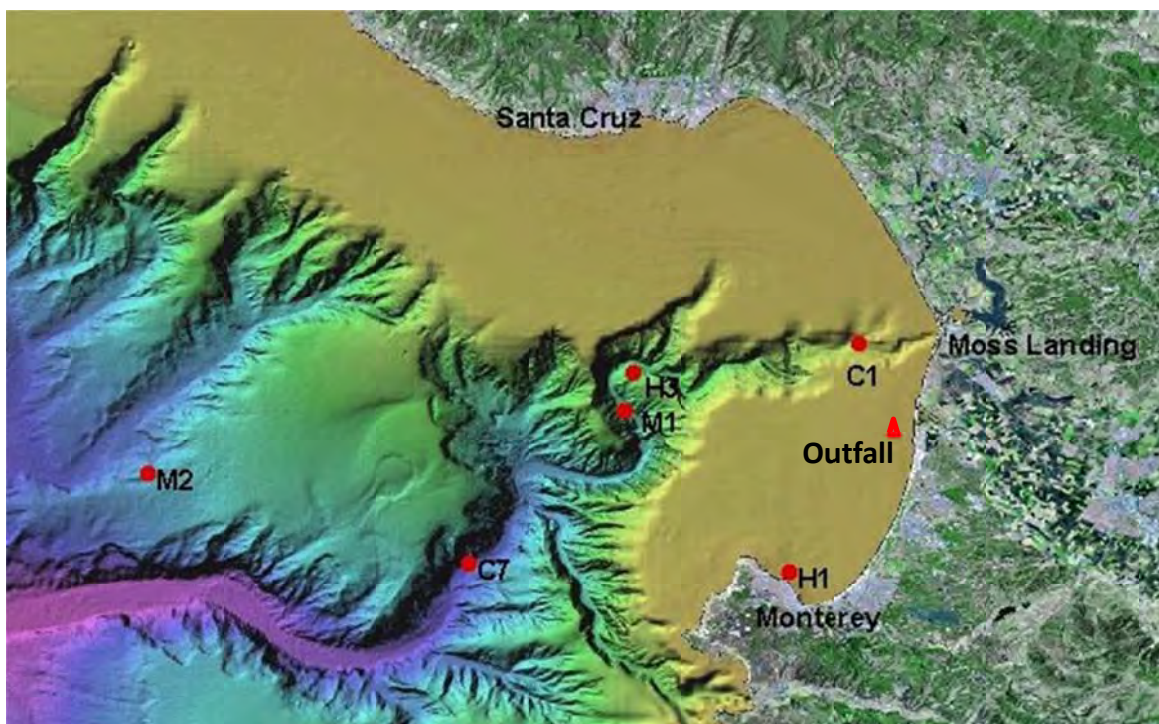

Figure C3. Location map, MBARI ocean monitoring stations and MRWPCA outfall.

Table C4 – Maximum and minimum ocean profile data.

Parameter	Season	Minimum	Maximum
Salinity (ppt)	Upwelling (July)	33.7	33.9
	Davidson (January)	33.2	33.5
	Oceanic (September)	33.5	33.6
Temperature (C°)	Upwelling (July)	10.0	13.0
	Davidson (January)	10.7	12.7
	Oceanic (September)	10.6	15.8

Source: ESA (2013); Appendix B.

Table C5 – Modeled seasonal ocean conditions.

Depth (m)	Upwelling (July)		Davidson (January)		Oceanic (September)	
	Temp. (°C)	Salinity (ppt)	Temp. (°C)	Salinity (ppt)	Temp. (°C)	Salinity (ppt)
0	12.98	33.78	12.65	33.20	15.75	33.46
2	12.87	33.77	12.65	33.22	15.75	33.46

Depth (m)	Upwelling (July)		Davidson (January)		Oceanic (September)	
	Temp. (°C)	Salinity (ppt)	Temp. (°C)	Salinity (ppt)	Temp. (°C)	Salinity (ppt)
4	12.64	33.74	12.65	33.22	15.75	33.46
6	11.97	33.71	12.65	33.23	15.53	33.46
8	11.61	33.70	12.74	33.24	14.46	33.46
10	11.34	33.70	12.57	33.26	13.81	33.46
12	11.10	33.73	12.50	33.28	13.17	33.46
14	10.84	33.75	12.42	33.30	12.27	33.46
16	10.51	33.78	12.33	33.30	11.83	33.46
18	10.38	33.79	12.24	33.30	11.52	33.46
20	10.38	33.80	12.22	33.28	11.19	33.46
22	10.38	33.80	12.07	33.30	11.06	33.46
24	10.38	33.82	12.05	33.30	11.22	33.49
26	10.38	33.82	11.90	33.30	11.39	33.50
28	10.38	33.84	11.81	33.32	11.39	33.50
30	10.38	33.84	11.71	33.34	11.31	33.50
32	10.37	33.84	11.71	33.37	11.23	33.50
34	10.31	33.84	11.63	33.39	11.22	33.50
36	10.30	33.84	11.63	33.42	11.05	33.50
38	10.30	33.84	11.54	33.43	10.97	33.50

Source: Interpolated from ESA | Water (2013) ocean profile data, Appendix B.

Receiving water flow conditions

As detailed in **Figure C1**, the existing diffuser ports are located just above the mid-point of the outfall pipe (i.e., below the crown of the outfall pipe), about 6 inches above the top of the ballast used to anchor the diffuser to the seafloor. Because the outfall rises above the seafloor, it will influence the patterns of currents (receiving water flow velocity) at the ports, and the current velocity at each individual port will be a complex function of the local geometry. Ocean currents increase the amount of dilution that occurs because they increase the flow of ambient water past the diffuser (i.e., increase the amount of ambient water available for mixing with the discharge). However, due to the complex outfall geometry, local field data collection would be required to characterize the actual current conditions and ambient turbulence levels at the diffuser ports, which was beyond the scope and budget of this analysis. To simplify the analysis, effluent dilution was analyzed for a uniform 0.0 fps current, which amounts to a “worst case,” stagnant (no current) receiving water condition. Stagnant conditions are typically used as the basis for developing NPDES permits, and the California Ocean Plan (SWRCB, 2009) requires the no-current condition be used in initial dilution calculations.

3. TRAJECTORY AND ZID OF A NEGATIVELY BUOYANT PLUME

The effluent and ocean profiles data presented in **Tables C1 and C5** indicate the effluent is negatively buoyant for some scenarios. A schematic sketch of the trajectory of a negatively buoyant jet is shown in **Figure C4**, where θ_0 is the port angle, d is the port diameter, s is distance in the direction of the port centerline, n is distance in the direction perpendicular to the port centerline, z_{me} is the maximum rise of the plume, M_0 is the initial momentum flux at the point of discharge, and M_b is the buoyancy-generated momentum flux. x_{OR} is the horizontal distance between the port and the point where the plume centerline returns to the port height level. In this analysis, the diffuser ports are about 3.5 ft above seafloor, and the impact point is the location where the plume centerline reaches seafloor.

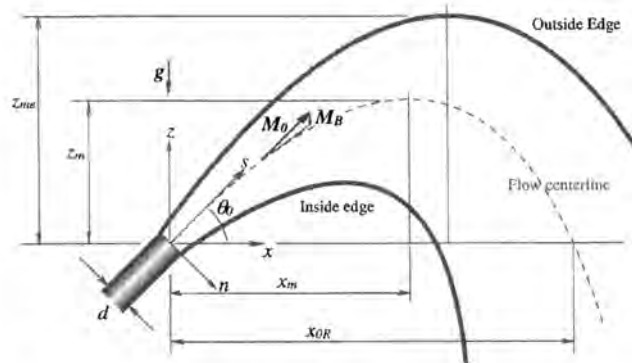

Fig. 1. Schematic diagram of the generic discharge configuration

Figure C4. Definition schematic for negatively buoyant jet (Kikkert, et al., 2007).

The methods described in **Section 4** were used to calculate the size of the plume and dilution of the discharged effluent within the “Zone of Initial Dilution,” or ZID. The ZID is defined as the zone immediately adjacent to a discharge where momentum and buoyancy-driven mixing produces rapid dilution of the discharge. In this analysis, the ZID ends at the point where the discharge plume impacts the seafloor for a dense (sinking) plume; for a positively buoyant (rising) effluent, the ZID ends at the point where the effluent plume reaches the water surface or attains a depth level where the density of the diluted effluent plume becomes the same as the density of ambient water (i.e., the “trap” level). Typically, within the ZID, which is limited in size, constituent concentrations are permitted to exceed water quality standards. A discharge is generally required to meet the relevant water quality standards at the edge of the ZID.

Beyond the point where the plumes reach the seafloor, some additional mixing will occur, and the discharged brine (now diluted) will travel along the seafloor as a density current. Based on the bathymetry near the diffuser, which steadily slopes out to sea, there is no “bowl” in which effluent could accumulate indefinitely. Rather, diluted effluent would flow downslope and gradually disperse. In the analysis presented here, the

spreading of the effluent on the seafloor (or within and beyond the trapping level) and the subsequent additional dilution that would ensue, have not been analyzed. Flow Science recommends that the computed dilution at the seafloor, or at the trapping level (i.e., at the end of the ZID) be used as the basis for any NPDES permitting activities and to analyze impacts.

4. PLUME ANALYSIS METHODS

Two analysis methods have been used to evaluate the discharge of desalination brines (negatively buoyant plumes) from the MRWPCA diffuser: a semi-empirical method based on the work of Roberts et al. (1997) and Kikkert et al. (2007), and EPA's Visual Plumes method. The Visual Plumes method was also used to model scenarios where the effluent density is less than seawater (positively buoyant, or rising, plumes). Both the semi-empirical method and Visual Plumes were used to characterize negatively buoyant plumes in order to understand the range of dilution that might be expected for discharge from the MRWPCA diffuser system. The semi-empirical method also provides some level of redundancy and confirmation of results because Visual Plumes, although widely used in diffuser discharge analysis, has only very recently been validated against limited experimental data for the case of a negatively buoyant plume. The main advantage of the semi-empirical analysis method is that it is well-grounded in empirical observations, and thus is well-tested and has been verified by comparison to a relatively large dataset for this specific discharge condition. The main disadvantage is that the semi-empirical method requires longer to complete an analysis for a given discharge scenario. The analysis techniques for these two methods are described below.

Semi-Empirical Analysis Method

Laboratory studies of negatively buoyant jets and plumes have been conducted by many researchers (e.g., Kikkert et al., 2007; Roberts et al., 1997). Most of these have been conducted for inclined jets (i.e., jets that discharge upward at an angle), which increase the initial mixing of the plume. Fewer studies are available to characterize the mixing of negatively buoyant plumes from horizontally-oriented discharge ports. In the following sections, the general equations for a negatively buoyant jet from an angled port are presented first. The equations for a horizontal discharge are then derived from the general equations.

Discharge of a negatively buoyant jet from an angled port

Plume trajectory

The trajectory of a negatively buoyant discharge under a stagnant flow condition (i.e., no ambient current) can be computed from the following equations (Kikkert, et al., 2007) (see **Figure C4** for nomenclature).

$$\frac{dn_*}{ds_*} = \frac{M_{B^*} \cos \theta_0}{1 - M_{B^*} \sin \theta_0} \quad (1)$$

where:

$$s_* = s/d$$

$$n_* = n/d$$

s and n are the distances in directions along and perpendicular to the discharge port centerline, respectively; d is the effective diameter of the port (see **Figure C4**); and M_{B^*} is the dimensionless buoyancy-generated momentum flux, which can be calculated from Eq. (2).

$$M_{B^*} = 0.154 \frac{s_*^2}{F_0^2} \quad (2)$$

where F_0 is the initial densimetric Froude number:

$$F_0 = \frac{U_0}{\sqrt{gd(\rho_0 - \rho_a)/\rho_a}}$$

where

U_0 = initial jet velocity

g = gravitational acceleration

ρ_0 = initial density of the jet

ρ_a = ambient water density

Substituting Eq. (2) into Eq. (1) and integrating gives an equation for the discharge trajectory:

$$n_* = \frac{2.6F_0}{\tan \theta_0 \sin^{1/2} \theta_0} \left[-\frac{s_* \sin^{1/2} \theta_0}{2.6F_0} + \frac{1}{2} \ln \left(\frac{2.6F_0 + s_* \sin^{1/2} \theta_0}{2.6F_0 - s_* \sin^{1/2} \theta_0} \right) \right] \quad (3)$$

Results from Eq. (3) agreed well with experimental data (Kikkert, et al., 2007).

Discharge of a negatively buoyant jet from a horizontal port

Plume trajectory

The plume trajectory of a horizontal discharge can be estimated using the equations for an angled jet. Specifically, for a horizontal discharge (i.e., $\theta_0=0$), Eq. (3) simplifies to the following relationship:

$$n_* = 0.051 \frac{s_*^3}{F_0^2} \quad (4)$$

Plume dilution for a horizontal discharge

For the horizontally discharged effluent, the empirical equations from Fischer et al., 1979 (Table 9.2, pp. 328) were used to compute the width and dilution of the effluent. i.e.,

$$\text{Plume width} = 2 * 0.13 * \text{distance along plume} \quad (5)$$

The plume width calculated from Eq. (5) defines the edge of the plume as the location where the concentration is 37% ($= e^{-1}$, which is often used to characterize plume width) of the centerline concentration.

The volume flux and dilution are specified by:

$$\text{Volume flux } \mu = 0.25M^{1/2} * \text{distance along plume} \quad (6)$$

$$\text{Dilution} = \mu / (\text{discharge flow rate}) \quad (7)$$

where $M=QU_0$ is the initial momentum flux of the effluent (Q and U_0 are the flow rate and initial velocity of the effluent, respectively).

Note that the semi-empirical analysis for 0° discharges uses Kikkert et al. (2007) for the trajectory and Fischer et al. (1979) for dilution.

Visual Plumes Analysis Method

Methodology

The UM3 model—part of the EPA Visual Plumes diffuser modeling package—was used to simulate the discharge of desalination brine and wastewater from the existing MRWPCA ocean diffuser. Visual Plumes is a mixing zone computer model developed

from a joint effort led by USEPA. Visual Plumes can simulate both single and merging submerged plumes, and density-stratified ambient flow can be specified by the user. Visual Plumes can be used to compute the plume dilution, trajectory, diameter, and other plume variables (USEPA, 2003).

The UM3 model is based on the projected area entrainment hypothesis, which assumes ambient fluid is entrained into the plume through areas projected in directions along the plume centerline and perpendicular to the centerline (USEPA, 1994). In addition, velocity shear entrainment is also included. The plume envelope is assumed to be in steady state, and as a plume element moves through the envelope, the element radius changes in response to velocity convergence or divergence, and entrainment of ambient fluid. Conservation equations of mass, momentum and energy are used to calculate plume mass and concentrations.

The actual depth of the diffuser ports varies between 95 and 109 feet below mean sea level (MSL) since the diffuser is quite long and is situated on a sloping portion of the ocean floor. However, since Visual Plumes cannot model a sloping diffuser, an average depth of 104 feet below MSL was used (the deepest 120 ports on the diffuser discharge in this case, thereby increasing the average port depth). Modeled ocean conditions are summarized in **Table C5**.

As with the semi-empirical method, Visual Plumes assumes circular discharge ports, so the actual elliptical discharge area of the Tideflex valves was calculated for each port (**Appendix A**) and then converted to an effective circular discharge diameter for use in Visual Plumes.

A study by Palomar et al. (2012a, 2012b) showed that the UM3 model of the Visual Plumes can be applied to simulate negatively buoyant discharges. However, the study also found that the UM3 model underpredicted centerline dilution ratios at the impact point by more than 50% for a negatively buoyant effluent discharged into a stagnant environment; for a number of scenarios with negatively buoyant effluent discharged into an ambient current, centerline dilution ratios at the impact point calculated by the UM3 model ranged from 40% lower to 7% higher than experimental data.

The UM3 model of the Visual Plumes was used in this analysis to model negatively buoyant effluent discharged into a stagnant environment. Because the study of Palomar et al. (2012a, 2012b) has shown that the centerline dilution ratios computed using the UM3 model were more than 50% lower than data from experiments with similar discharge conditions, the average dilution ratios calculated using UM3, which are nearly double the centerline dilution ratios, were used to estimate dilution of negatively buoyant plumes in this analysis. Since Visual Plumes has been more thoroughly validated for positively buoyant plumes, it alone was used for scenarios with rising plumes.

5. DILUTION RESULTS

Results for thirteen new scenarios (“Task 1” Scenarios)

For the scenarios presented in **Table C1**, several key results for the effluent plumes are reported at the edge of the ZID. As noted above, the ZID is defined as the zone immediately adjacent to a discharge where momentum and buoyancy-driven mixing produces rapid dilution of the discharge. Results for positively buoyant plumes presented in this Technical Memorandum were taken at the point where the plumes just reach the trap level, which is the depth level where the density of the diluted plume becomes the same as ambient seawater. Horizontal spreading of plumes at their trap levels was not included in this analysis because it is beyond the ZID. Results from each scenario generally include the following quantities:

- the horizontal distance from the diffuser port to the point at which the plume impacts the seafloor or reaches the trap level.
- the dilution of the plume at the point at which the plume impacts the seafloor or reaches the trap level. For the semi-empirical method of analyzing negatively buoyant plumes and for the Visual Plumes analyses of rising plumes, centerline dilution is provided. For the Visual Plumes analyses of negatively buoyant discharges, the average dilution within the plume is provided, in recognition of the conservative nature of Visual Plumes results for negatively buoyant plumes (see, e.g., Palomar et al., 2012a and 2012b).
- an estimate of the size of the plume (diameter) at the point of impact or just below the trap level (i.e., at the edge of the ZID).
- the maximum salinity at the seafloor (edge of ZID for negatively buoyant plumes).
- the percentage by which the maximum plume salinity at the seafloor (edge of ZID for negatively buoyant plumes) exceeds the ambient salinity.

Figure C5 shows a sample schematic graphic of the trajectory of a negatively buoyant plume from a horizontal discharge drawn approximately to scale. As the effluent travels away from the discharge port, it entrains ambient seawater, which increases the diameter of the plume and decreases the plume concentration.

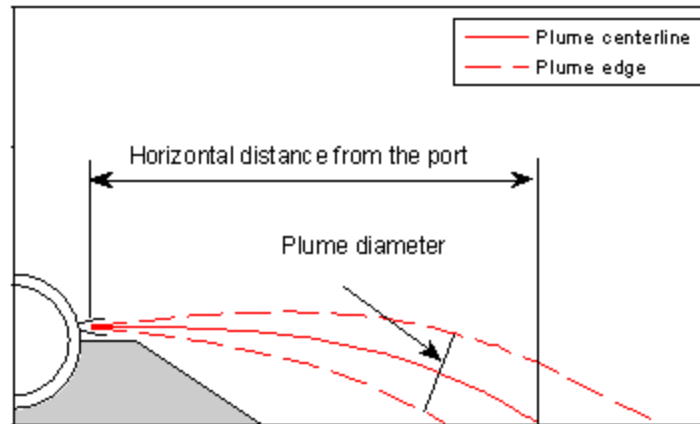

Figure C5. Sample graphic showing plume trajectory for the horizontal discharge configuration.

Table C6 presents analysis results for the 13 modeled scenarios of Task 1. The plumes were positively buoyant (i.e., had densities less than ambient seawater) for scenarios where the desalination brine was mixed with treated wastewater and for GWR Project scenarios. This is mainly because the salinity of the plumes in these scenarios was much lower than ambient seawater. The plumes were negatively buoyant (i.e., were denser than ambient seawater) for desalination brine only and for desalination brine mixed with GWR Project brine. Results in **Table C6** show that the trajectory, diameter and dilution of the negatively buoyant plumes were nearly the same across all three modeled seasons, because the trajectories of these negatively buoyant plumes were short and close to the seafloor, where the differences in salinity and temperature (hence the difference in density) between the effluent and ambient sea water changed only slightly over the modeled seasons. Therefore, for analyses of scenarios involving negatively buoyant, i.e., sinking, plumes, characteristics of the resulting plumes were similar for all seasons.

Dilution values predicted by the semi-empirical method were lower than the dilution values predicted by the Visual Plumes method. The predicted maximum plume salinity at the seafloor was 1.6 ppt above ambient ocean salinity.



Table C6 – Analysis results.

Analysis number	Effluent discharge flow rate (mgd) & component	Discharge Velocity (feet/second)	Seasonal Condition	Effluent salinity (ppt)	Ocean bkgd. salinity at diffuser depth (ppt)	Semi-empirical method						VP method					
						Plume diam. (d) (inch)	Center-line Dilution	Horiz. Distance from port (ft)	Max. height above port (z_{me}) (ft)	Plume salinity at calc. dilution (ppt)	Salinity increase above ambient (ppt)	Plume diam. (inch)	Average Dilution	Horiz. Distance from port (ft)	Max. height above port (z_{me}) (ft)	Plume salinity at calc. dilution (ppt)	Salinity increase above ambient (ppt)
0.0	19.78 WW	11.5	Davidson (Jan.)	0.8	33.36	--	--	--	--	--	--	246	167 ^a	27	69 ^b	--	--
5.1	8.99 BR	7.5	Upwelling (July)	58.23	33.84	31	15	10	--	35.47	1.6	36	25	8	--	34.82	1.0
6.1	8.99 BR	7.5	Davidson (Jan.)	57.40	33.36	31	15	10	--	34.98	1.6	36	26	8	--	34.30	0.9
7.1	28.77 BR+WW	13.9	Davidson (Jan.)	18.48	33.36	--	--	--	--	--	--	207	84 ^a	38	41 ^b	--	--
8.1	8.99 BR	7.5	Oceanic (Sept.)	57.64	33.50	31	15	10	--	35.11	1.6	36	25	8	--	34.47	1.0
9.1	9.72 BR+GWR	8	Upwelling (July)	54.16	33.84	34	17	11	--	35.04	1.2	39	27	8	--	34.59	0.8
10.1	9.72 BR+GWR	8	Davidson (Jan.)	53.39	33.36	34	17	11	--	34.55	1.2	40	27	8	--	34.12	0.8
11.1	25.64 BR+WW+GWR	13.1	Davidson (Jan.)	20.73	33.36	--	--	--	--	--	--	204	82 ^a	38	38 ^b	--	--
12.1	9.72 BR+GWR	8	Oceanic (Sept.)	53.61	33.50	34	17	11	--	34.68	1.2	39	27	8	--	34.24	0.7

Source: Flow Science Analysis, 2014.

BR: desalination brine. WW: wastewater. GWR: groundwater recharge.

^a Dilution values are centerline dilution because the Visual Plumes model has been validated for positively buoyant plumes and no significant underprediction of dilution has been reported.

^b These values are trap levels above the diffuser.



Table C6 – Analysis results (continued).

Analysis number	Effluent discharge flow rate (mgd) & component	Discharge Velocity (feet/second)	Seasonal Condition	Effluent salinity (ppt)	Ocean bkgd. salinity at diffuser depth (ppt)	Semi-empirical method						VP method					
						Plume diam. (d) (inch)	Center-line Dilution	Horiz. Distance from port (ft)	Max. height above port (z_{me}) (ft)	Plume salinity at calc. dilution (ppt)	Salinity increase above ambient (ppt)	Plume diam. (inch)	Average Dilution	Horiz. Distance from port (ft)	Max. height above port (z_{me}) (ft)	Plume salinity at calc. dilution (ppt)	Salinity increase above ambient (ppt)
13.1	0.73 GWR	3.4	Upwelling (July)	4	33.84	--	--	--	--	--	--	159	777 ^a	6	48 ^b	--	--
14.1	0.73 GWR	3.4	Davidson (Jan.)	4	33.36	--	--	--	--	--	--	86	270 ^a	5	24 ^b	--	--
15.1	16.65 WW+GWR	11	Davidson (Jan.)	0.9	33.36	--	--	--	--	--	--	243	180 ^a	24	68 ^b	--	--
16.1	0.73 GWR	3.4	Oceanic (Sept.)	4	33.50	--	--	--	--	--	--	121	678 ^a	5	41 ^b	--	--

Source: Flow Science Analysis, 2014.

BR: desalination brine. WW: wastewater. GWR: groundwater recharge.

^a Dilution values are centerline dilution because the Visual Plumes model has been validated for positively buoyant plumes and no significant underprediction of dilution has been reported.

^b These values are trap levels above the diffuser.

Impact of Discharge Rate on Effluent Dilution and Salinity

To explore the impact of the brine discharge rate on effluent dilution ratio and to determine the desalination brine discharge rate that results in salinity at the seafloor that exceeds ambient salinity levels by no more than 2 ppt, a series of brine discharge rates were analyzed using both the Visual Plumes model and the semi-empirical method. For this analysis, the desalination brine was assumed to be the only effluent discharged from the diffuser. The dilution and salinity levels for these scenarios are summarized in **Table C7**. **Figure C6** and **Figure C7** graphically present the effluent salinity (in ppt above ambient salinity) calculated using the semi-empirical method and the Visual Plumes method, respectively, at the impact point as a function of desalination brine discharge flow rates.

Results of the semi-empirical method showed that salinity values within the plume at the impact point were predicted to increase (i.e., dilution decreased) for desalination brine discharge rates up to 8 mgd in January and September and 10 mgd in July; salinity values then decreased (dilution increased) for higher discharge rates. The highest effluent salinity at the impact point was 1.6 ppt above ambient salinity.

The highest effluent salinity calculated by the Visual Plumes method was 1.0 ppt above ambient salinity. Results of the Visual Plumes method also showed that salinity at the impact point was predicted to increase (i.e., simulated dilution decreased) for desalination brine discharge rates up to 10 mgd for January and 8 mgd for July and September. Dilution and impact point salinity values remained nearly constant for higher discharge rates. It should be noted that although effluent dilution ratio remained almost unchanged, more ambient seawater was entrained into the plume for scenarios with higher discharge rates. The increase in entrained seawater was approximately proportional to the increase in discharge rate, so the dilution ratio remained almost unchanged. The 65 mgd discharge rate, the highest discharge rate analyzed, translates to a single port flow of about 0.84 cfs. Assuming it takes 10 seconds for the effluent to reach the impact point, the volume of the brine is about 8.4 ft³. Port spacing on one side of the diffuser is 16 ft (ports are 8 ft apart on alternating sides of the diffuser), ports are about 3.5 ft above seafloor, and the impact point is about 10 ft away from the ports. This gives a seawater volume of about 560 ft³ around one port, which is about 67 times the brine volume. Therefore even for the highest analyzed discharge rate, there is enough seawater to dilute the brine. It should be pointed out that despite remaining nearly unchanged for discharge rates in the range of 10 to 65 mgd, the dilution ratio may change for discharge rates higher than 65 mgd. For brine discharge rates much higher than 65 mgd, effluent plumes from neighboring ports may merge and there might not be enough seawater to dilute the effluent, and as a result, the effluent dilution ratio will be lower and salinity values will be higher.

Table C7 – Analysis results for various desalination brine-only discharge rates.

Flow mgd	Semi-empirical method						VP method					
	Jan.		July		Sept.		Jan.		July		Sept.	
	Dilution	Salinity increase above ambient (ppt)	Dilution	Salinity increase above ambient (ppt)	Dilution	Salinity increase above ambient (ppt)	Dilution	Salinity increase above ambient (ppt)	Dilution	Salinity increase above ambient (ppt)	Dilution	Salinity increase above ambient (ppt)
0.5	19	1.3	19	1.3	19	1.3	48	0.5	49	0.5	48	0.5
1	17	1.4	17	1.5	17	1.4	39	0.6	39	0.6	39	0.6
2	16	1.5	16	1.6	16	1.5	33	0.7	33	0.7	33	0.7
3	15	1.6	15	1.6	15	1.6	30	0.8	30	0.8	30	0.8
4	15	1.6	15	1.6	15	1.6	28	0.8	28	0.9	28	0.9
6	15	1.6	15	1.6	15	1.6	26	0.9	26	0.9	26	0.9
8	15	1.6	15	1.6	15	1.6	26	0.9	25	1.0	25	0.9
10	16	1.5	15	1.6	16	1.6	25	0.9	25	1.0	25	1.0
12	16	1.5	16	1.5	16	1.5	25	0.9	25	1.0	25	1.0
14	16	1.5	16	1.5	16	1.5	25	0.9	25	1.0	25	1.0
16	17	1.4	16	1.5	17	1.5	25	1.0	25	1.0	25	1.0
18	17	1.4	17	1.4	17	1.4	25	0.9	25	1.0	25	1.0
20	17	1.4	17	1.4	17	1.4	25	1.0	25	1.0	25	1.0
22	18	1.4	17	1.4	17	1.4	25	1.0	25	1.0	25	1.0
24	18	1.3	18	1.4	18	1.4	25	0.9	25	1.0	25	1.0
26	18	1.3	18	1.4	18	1.3	25	1.0	25	1.0	25	1.0
28	18	1.3	18	1.3	18	1.3	25	0.9	25	1.0	25	1.0
30	18	1.3	18	1.3	18	1.3	25	1.0	25	1.0	25	1.0
32	19	1.3	19	1.3	19	1.3	25	0.9	25	1.0	25	1.0
34	19	1.3	19	1.3	19	1.3	25	1.0	25	1.0	25	1.0
36	19	1.2	19	1.3	19	1.3	25	1.0	25	1.0	25	1.0
38	19	1.2	19	1.3	19	1.3	25	1.0	25	1.0	25	1.0
40	20	1.2	19	1.3	19	1.2	25	1.0	25	1.0	25	1.0
45	20	1.2	20	1.2	20	1.2	25	0.9	25	1.0	25	1.0
50	20	1.2	20	1.2	20	1.2	25	0.9	25	1.0	25	1.0
55	21	1.1	21	1.2	21	1.2	25	0.9	25	1.0	25	1.0
60	21	1.1	21	1.2	21	1.1	25	0.9	25	1.0	25	1.0
65	22	1.1	22	1.1	22	1.1	25	0.9	25	1.0	25	1.0

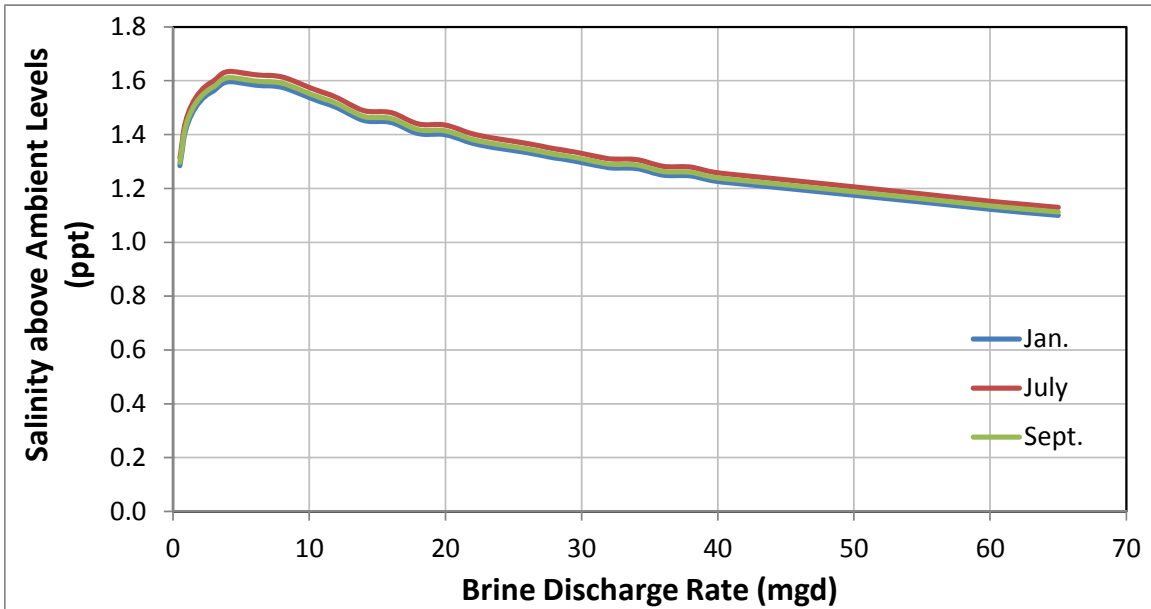

Figure C6. Simulated seafloor salinity (ppt above ambient salinity) for desalination brine calculated using the semi-empirical method.

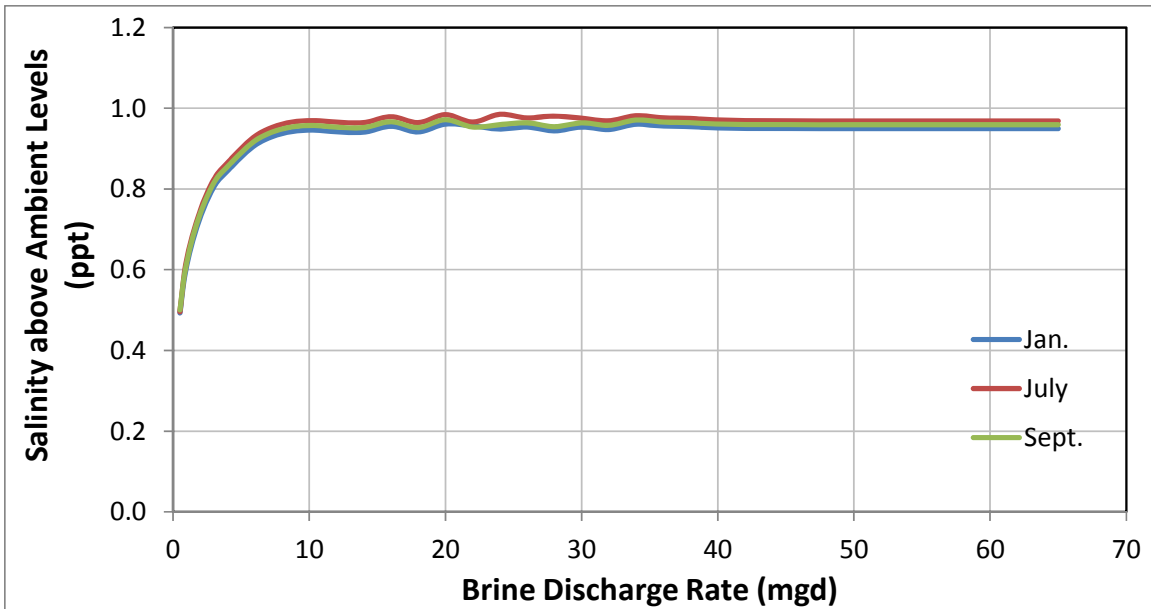

Figure C7. Simulated seafloor salinity (ppt above ambient salinity) for desalination brine calculated using the Visual Plumes method.

Impact of Seawater Pre-dilution on Effluent Dilution and Salinity

To reduce effluent salinity, seawater could be used to pre-dilute the desalination brine before discharging to the outfall pipeline. The impact of seawater pre-dilution on effluent dilution and salinity was evaluated for a series of discharge scenarios using both the Visual Plumes method and the semi-empirical method. In these scenarios, the flow rate of pre-dilution seawater was varied; the discharge rate of desalination brine was fixed at 13.98 mgd. The temperature and salinity of the desalination brine and seawater are summarized in **Table C3**, and temperature and salinity of the pre-diluted discharge was calculated as flow-weighted averages of the desalination brine and seawater. The effluent dilution and seafloor salinity for the pre-dilution scenarios are presented in **Table C8**. **Figure C8** and **Figure C9** show the salinity exceedence for the pre-dilution scenarios calculated using the semi-empirical method and the Visual Plumes method, respectively.

Results from both methods showed that the maximum seafloor salinity was simulated to decrease as the amount of seawater used to pre-dilute the desalination brine increased. Results of the semi-empirical method indicated that the highest effluent salinity at seafloor was 1.4 ppt above ambient salinity. Results from the Visual Plumes method showed that effluent salinity at seafloor was less than 0.9 ppt above ambient salinity.

Table C8 – Analysis results for seawater pre-dilution.

Flow		Semi-empirical method						VP method					
Mgd		Jan.		July		Sept.		Jan.		July		Sept.	
Sea-water	Sea-water + brine	Dilution	Salinity increase above ambient (ppt)	Dilution	Salinity increase above ambient (ppt)	Dilution	Salinity increase above ambient (ppt)	Dilution	Salinity increase above ambient (ppt)	Dilution	Salinity increase above ambient (ppt)	Dilution	Salinity increase above ambient (ppt)
0.5	14.48	17	1.4	17	1.4	17	1.4	25	0.9	26	0.9	25	0.9
1	14.98	17	1.3	17	1.4	17	1.3	26	0.9	26	0.9	26	0.9
2	15.98	17	1.2	17	1.2	17	1.2	26	0.8	26	0.8	26	0.8
3	16.98	18	1.1	18	1.1	18	1.1	26	0.8	26	0.8	26	0.8
4	17.98	18	1.0	18	1.0	18	1.0	26	0.7	26	0.7	26	0.7
5	18.98	19	0.9	19	1.0	19	0.9	27	0.7	27	0.7	27	0.7
6	19.98	19	0.9	19	0.9	19	0.9	27	0.6	26	0.6	26	0.6
8	21.98	20	0.8	20	0.8	20	0.8	27	0.6	27	0.6	27	0.6
10	23.98	21	0.7	21	0.7	21	0.7	27	0.5	27	0.5	27	0.5
12	25.98	22	0.6	22	0.6	22	0.6	28	0.5	28	0.5	28	0.5
14	27.98	23	0.5	23	0.5	23	0.5	28	0.4	28	0.4	28	0.4
16	29.98	24	0.5	23	0.5	23	0.5	28	0.4	28	0.4	28	0.4
18	31.98	24	0.4	24	0.4	24	0.4	29	0.4	29	0.4	29	0.4

Flow		Semi-empirical method						VP method					
Mgd		Jan.		July		Sept.		Jan.		July		Sept.	
Sea-water	Sea-water + brine	Dilution	Salinity increase above ambient (ppt)	Dilution	Salinity increase above ambient (ppt)	Dilution	Salinity increase above ambient (ppt)	Dilution	Salinity increase above ambient (ppt)	Dilution	Salinity increase above ambient (ppt)	Dilution	Salinity increase above ambient (ppt)
20	33.98	25	0.4	25	0.4	25	0.4	29	0.3	29	0.4	29	0.3
22	35.98	26	0.4	26	0.4	26	0.4	29	0.3	29	0.3	29	0.3
24	37.98	26	0.3	26	0.3	26	0.3	29	0.3	29	0.3	29	0.3
26	39.98	27	0.3	27	0.3	27	0.3	29	0.3	29	0.3	29	0.3
28	41.98	28	0.3	28	0.3	28	0.3	29	0.3	29	0.3	29	0.3
30	43.98	29	0.3	28	0.3	29	0.3	29	0.3	29	0.3	29	0.3
35	48.98	30	0.2	30	0.2	30	0.2	30	0.2	30	0.2	30	0.2
40	53.98	32	0.2	32	0.2	32	0.2	30	0.2	30	0.2	30	0.2

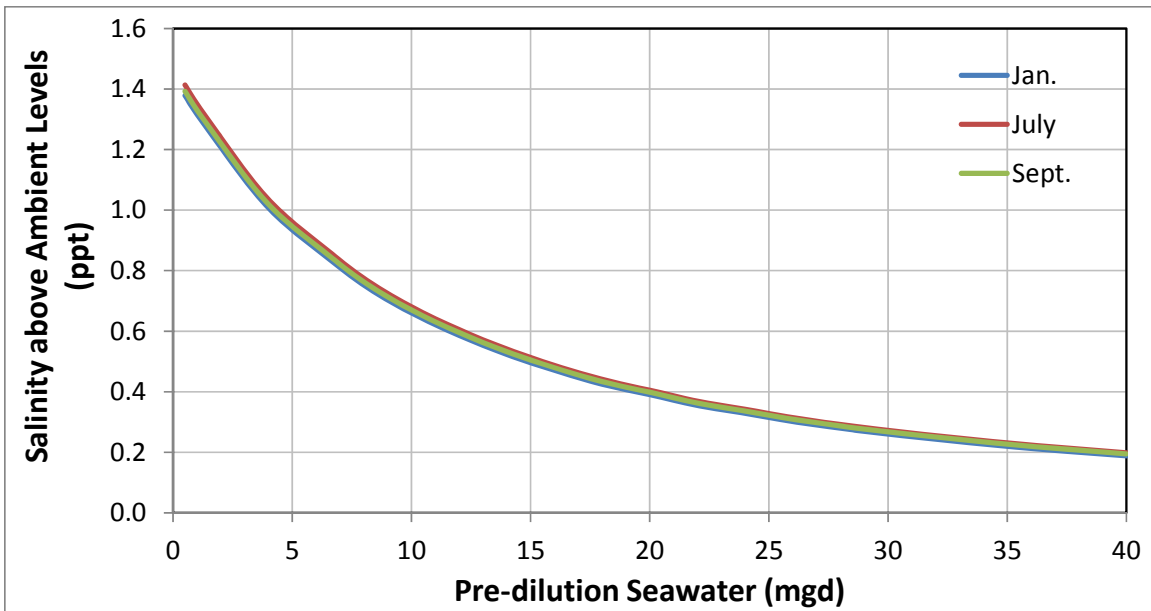

Figure C8. Simulated seafloor salinity (ppt above ambient salinity) for desalination brine (13.98 mgd) as a function of the flow rate of pre-dilution seawater; results calculated using the semi-empirical method.

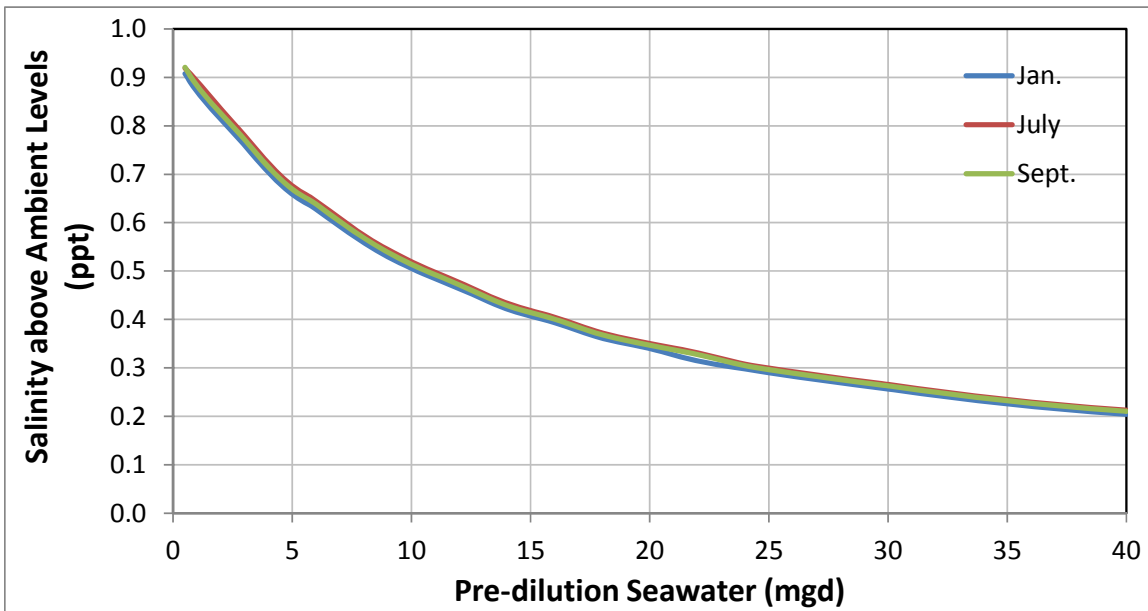

Figure C9. Simulated seafloor salinity (ppt above ambient salinity) for desalination brine (13.84 mgd) as a function of the flow rate of pre-dilution seawater; results calculated using the Visual Plumes method.

Impact of Treated Wastewater Pre-dilution on Effluent Dilution and Salinity

Instead of seawater, treated wastewater could also be used to pre-dilute the desalination brine before discharging to the outfall pipeline. The impact of treated wastewater pre-dilution on effluent dilution and salinity was evaluated for a number of discharge scenarios using both the Visual Plumes method and the semi-empirical method. In these scenarios, the flow rate of pre-dilution wastewater was varied; the discharge rate of desalination brine was fixed at 13.98 mgd. The temperature and salinity of the desalination brine and wastewater are summarized in **Table C3**, and temperature and salinity of the pre-diluted discharge was calculated as flow-weighted averages of the desalination brine and wastewater. The effluent dilution and seafloor salinity for the pre-dilution scenarios are presented in **Table C9**.

Results from both methods showed that the maximum seafloor salinity was simulated to decrease as the amount of treated wastewater used to pre-dilute the desalination brine increased. Results of both the semi-empirical method and the Visual Plumes method indicated that effluent salinity at seafloor was less than 2 ppt above ambient salinity for all three seasonal conditions.

Table C9 – Analysis results for treated wastewater pre-dilution.

Flow		Semi-empirical method						VP method					
mgd		Jan.		July		Sept.		Jan.		July		Sept.	
Waste water	Waste water + brine	Dilution	Salinity increase above ambient (ppt)	Dilution	Salinity increase above ambient (ppt)	Dilution	Salinity increase above ambient (ppt)	Dilution	Salinity increase above ambient (ppt)	Dilution	Salinity increase above ambient (ppt)	Dilution	Salinity increase above ambient (ppt)
0.25	14.23	17	1.4	17	1.4	17	1.4	26	0.9	26	0.9	26	0.9
0.5	14.48	17	1.3	17	1.3	17	1.3	26	0.9	26	0.9	26	0.9
1	14.98	18	1.2	17	1.2	18	1.2	26	0.8	26	0.8	26	0.8
2	15.98	19	0.9	19	0.9	19	0.9	27	0.6	27	0.6	27	0.6

5. REFERENCES

- Fischer, H.B., List, E. J., Koh, R. C. Y., Imberger, J. Brooks, N. H. (1979) *Mixing in Inland and Coastal Waters*, Academic Press, 483 pp.
- Flow Science (2014). *Draft Technical Memorandum: MRWPCA brine discharge diffuser analysis*. August 25, 2014.
- GeoScience (2008). *North Marina Ground Water Model*. Evaluation of Potential Projects, July 25.
- Kikkert, G.A.; Davidson, J.; and Nokes, R.I. (2007). *Inclined Negatively Buoyant Discharges*. *Journal of Hydraulic Engineering*, 133(5), pp545-554.
- Palomar, P., Lara, J.L., Losada, I.J., Rodrigo, M., and Álvarez, A. (2012a). *Near Field Brine Discharge Modelling Part 1: Analysis of Commercial Tools*. *Desalination* 290, pp14-27.
- Palomar, P., Lara, J.L., Losada, I.J., Rodrigo, M., and Álvarez, A. (2012b). *Near Field Brine Discharge Modelling Part 2: Validation of Commercial Tools*. *Desalination* 290, pp28-42.
- Roberts, P. J.W.; Ferrer, A.; and Daviero, G. (1997). *Mixing in Inclined Dense Jets*. *Journal of Hydraulic Engineering*, 123(8), pp693-699.
- State Water Resources Control Board (2009). *California Ocean Plan, Water Quality Control Plan for Ocean Waters of California*.
- USEPA (1994). *Dilution Models for Effluent Discharges (3rd edition)*. EPA/600/R-94/086, June, 1994.
- USEPA (2003). *Dilution Models for Effluent Discharges (4th edition)*. EPA/600/R-03/025, March, 2003.